

# xNode

Installation & User's Guide



THE TELOS ALLIANCE®

Manual Rev 2.2.2 - February 2019

[TelosAlliance.com](http://TelosAlliance.com)

# User Warnings and Cautions

The installation and service instructions in this manual are for use by qualified personnel only. To avoid electric shock, do not perform any servicing other than that contained in the operating instructions unless you are qualified to do so. Refer all servicing to qualified personnel

This instrument has an autoranging line voltage input. Ensure the power voltage is within the specified range of 100-240VAC. The ~ symbol, if used, indicates an alternating current supply.



This symbol, wherever it appears, alerts you to the presence of uninsulated, dangerous voltage inside the enclosure – voltage which may be sufficient to constitute a risk of shock.



This symbol, wherever it appears, alerts you to important operating and maintenance instructions. Read the manual.

## CAUTION: HAZARDOUS VOLTAGES

The instrument power supply incorporates an internal fuse. Hazardous voltages may still be present on some of the primary parts even when the fuse has blown. If fuse replacement is required, replace fuse only with same type and value for continued protection against fire.

## WARNING:

The product's power cord is the primary disconnect device. The socket outlet should be located near the device and easily accessible. The unit should not be located such that access to the power cord is impaired. If the unit is incorporated into an equipment rack, an easily accessible safety disconnect device should be included in the rack design.

To reduce the risk of electrical shock, do not expose this product to rain or moisture. This unit is for indoor use only.

This equipment requires the free flow of air for adequate cooling. Do not block the ventilation openings on the rear and sides of the unit. Failure to allow proper ventilation could damage the unit or create a fire hazard. Do not place the units on a carpet, bedding, or other materials that could interfere with any panel ventilation openings.

If the equipment is used in a manner not specified by the manufacturer, the protection provided by the equipment may be impaired.

## USA CLASS A COMPUTING DEVICE INFORMATION TO USER.

### WARNING:

This equipment generates, uses, and can radiate radio-frequency energy. If it is not installed and used as directed by this manual, it may cause interference to radio communication. This equipment complies with the limits for a Class A computing device, as specified by FCC rules, part 15, subpart j, which are designed to provide reasonable protection against such interference when this type of equipment is operated in a commercial environment. Operation of this equipment in a residential area is likely to cause interference. If it does, the user will be required to eliminate the interference at the user's expense. Note: objectionable interference to TV or radio reception can occur if other devices are connected to this device without the use of shielded interconnect cables. FCC rules require the use of shielded cables.

## **CANADA WARNING:**

“This digital apparatus does not exceed the Class A limits for radio noise emissions set out in the radio interference regulations of the Canadian department of communications.”

“Le présent appareil numérique n’émet pas de bruits radioélectriques dépassant les limites applicables aux appareils numériques (de Class A) prescrites dans le règlement sur le brouillage radioélectrique édicté par le ministère des communications du Canada.”

## **CE CONFORMANCE INFORMATION:**

This device complies with the requirements of the EEC council directives:

93/68/EEC (CE MARKING)

73/23/EEC (SAFETY – LOW VOLTAGE DIRECTIVE)

89/336/EEC (ELECTROMAGNETIC COMPATIBILITY)

Conformity is declared to those standards: EN50081-1, EN50082-1.

## **Trademarks, Patents, and Licenses**

Telos Alliance is a trademark of TLS Corp. All other trademarks are the property of their respective holders.

All versions, claims of compatibility, trademarks, etc. of hardware and software products not made by The Telos Alliance which are mentioned in this manual or accompanying material are informational only. The Telos Alliance makes no endorsement of any particular product for any purpose, nor claims any responsibility for operation or accuracy. We reserve the right to make improvements or changes in the products described in this manual which may affect the product specifications, or to revise the manual without notice.

This document and its content are copyrighted by TLS Corporation and may not be copied, reproduced, or distributed in any form without expressed written permission.

Patent information can be found at [www.TelosAlliance.com/legal](http://www.TelosAlliance.com/legal)

### **Updates**

Telos Alliance xNode features and operations are determined largely by software. The Telos Alliance strives to provide the most stable and feature-rich software available. We encourage you to check for software updates from time to time by visiting our website or by contacting us directly.

### **Feedback**

We welcome feedback on any aspect of our products or this manual. In the past, many good ideas from users have made their way into software revisions or new products. Please contact us with your comments or suggestions.

## **We support you...**

### **By Phone/Fax**

You may reach our Telos Support Team in emergencies by calling +1 216-622-0247. For billing questions or other non-emergency technical questions, call +1 216-241-7225 between 9:00 AM to 5:00 PM USA Eastern Time, Monday through Friday.

**By Email**

Non-emergency technical support is available at [Support@TelosAlliance.com](mailto:Support@TelosAlliance.com).

**By Web**

The Telos Alliance Web site has a variety of information that may be useful for product selection and support. The URL is [TelosAlliance.com](http://TelosAlliance.com).

**Service**

You must contact Telos Alliance before returning any equipment for factory service. We will need your unit's serial number, located on the back of the unit. We will issue a return authorization number, which must be written on the exterior of your shipping container. Please do not include cables or accessories unless specifically requested by the Technical Support Engineer. Be sure to adequately insure your shipment for its replacement value. Packages without proper authorization may be refused. US customers, please contact Telos Alliance Technical Support at +1-216-622-0247. All other customers should contact local representative to make arrangements for service.

## Warranty



For the latest Telos Alliance warranty, visit: [telosalliance.com/warranty](http://telosalliance.com/warranty)

**Register your product**

Register your product today to get the full benefits of our warranty, support, and product updates. [telosalliance.com/product-registration/](http://telosalliance.com/product-registration/)

**The Telos Alliance**

1241 Superior Ave. Cleveland, OH 44114 USA  
+1 (216) 241-7225

**For Telos Support:**

24/7 telephone: +1 (216) 622-0247

Email: [support@telosalliance.com](mailto:support@telosalliance.com)

Web: [telosalliance.com/support-request](http://telosalliance.com/support-request)

# Table of Contents

User Warnings and Cautions . . . . .	ii
Warranty . . . . .	iv
The Most Exciting and Engaging Audio Experiences . . . . .	viii
<b>Chapter One: Introducing the xNode . . . . .</b>	<b>1</b>
The Front Panel . . . . .	2
Rear Panel . . . . .	3
<i>Analog</i> . . . . .	3
<i>AES/EBU</i> . . . . .	3
<i>Microphone</i> . . . . .	4
<i>GPIO</i> . . . . .	4
<i>Mixed Signal</i> . . . . .	4
<b>Chapter Two: Configuration . . . . .</b>	<b>6</b>
<i>Fast Setup</i> . . . . .	6
<i>Assigning an IP address manually</i> . . . . .	8
<i>Assigning an ID</i> . . . . .	8
<i>iProbe configuration</i> . . . . .	9
<i>Web interface configuration (“Simple setup”)</i> . . . . .	9
<i>Restoring Defaults</i> . . . . .	10
<b>Chapter Three: The xNode in depth . . . . .</b>	<b>11</b>
<i>Mounting</i> . . . . .	11
<i>Optional Surface Mount kit</i> . . . . .	11
<i>Optional Rack Mount kit</i> . . . . .	12
<i>Revision 2</i> . . . . .	14
<i>Revision 1</i> . . . . .	15
<i>Home</i> . . . . .	16
<i>Simple Setup</i> . . . . .	16
<i>Web interface (Advanced options)</i> . . . . .	17
<i>System</i> . . . . .	17
<i>QOS (Audio xNodes)</i> . . . . .	18
<i>PTP characterizations</i> . . . . .	19
<i>Meters (Audio xNodes)</i> . . . . .	20
<i>Mixer (Audio xNodes)</i> . . . . .	21
<i>Destinations (Audio xNode)</i> . . . . .	22
<i>Sources (Audio xNode)</i> . . . . .	23
<i>Unicast Link</i> . . . . .	23
<b>Chapter Four: Analog xNode . . . . .</b>	<b>25</b>
Rear Panel . . . . .	25
<i>The pinout of an RJ-45 port</i> . . . . .	25
<i>The pinout of the DB-25</i> . . . . .	26

<b>Chapter Five: AES xNode</b> . . . . .	<b>27</b>
<i>The pinout of an RJ-45 port</i> . . . . .	27
<i>The pinout of the DB-25</i> . . . . .	28
<b>Chapter Six: Microphone xNode</b> . . . . .	<b>29</b>
<i>The pinout of the DB-25</i> . . . . .	30
<i>(Microphone Inputs 1-4)</i> . . . . .	30
<i>(Analog Line Outputs 1-4)</i> . . . . .	31
<b>Chapter Seven: GPIO xNode</b> . . . . .	<b>32</b>
<i>Simple Setup</i> . . . . .	35
<i>Other Web Interfaces</i> . . . . .	36
<i>Home</i> . . . . .	36
<i>System</i> . . . . .	36
<b>Chapter Eight: Mixed Signal xNode</b> . . . . .	<b>37</b>
<i>The pinout of an RJ-45 port</i> . . . . .	37
<i>Simple Setup</i> . . . . .	40
<b>Appendix A: GPIO Logic Table Samples</b> . . . . .	<b>41</b>
<i>GPIO Operator's Microphone Logic</i> . . . . .	41
<i>GPIO Control Room Guest Microphone Logic</i> . . . . .	42
<i>GPIO Producer's Microphone Logic</i> . . . . .	43
<i>GPIO Line Input Logic</i> . . . . .	44
<i>GPIO Codec Logic</i> . . . . .	45
<i>GPIO Telephone Hybrid Logic</i> . . . . .	46
<i>GPIO Control Room Monitor Logic</i> . . . . .	47
<i>GPIO Computer Playback Device Logic</i> . . . . .	48
<b>Appendix B: xNode Specifications</b> . . . . .	<b>49</b>
<i>Microphone Preamplifiers</i> . . . . .	49
<i>Analog Line Inputs</i> . . . . .	49
<i>Analog Line Outputs</i> . . . . .	49
<i>Digital Audio Inputs and Outputs</i> . . . . .	49
<i>Frequency Response</i> . . . . .	49
<i>Latency</i> . . . . .	49
<i>Dynamic Range</i> . . . . .	50
<i>Equivalent Input Noise</i> . . . . .	50
<i>Total Harmonic Distortion + Noise</i> . . . . .	50
<i>Crosstalk Isolation, Stereo Separation and CMRR</i> . . . . .	50
<i>Power Supply AC Input</i> . . . . .	50
<i>Operating Temperatures</i> . . . . .	50
<i>Dimensions and Weight</i> . . . . .	50

**Appendix C: AES67 . . . . . 51**  
    *Network synchronization setup*. . . . . 51  
    *AES67 Multicast connection setup* . . . . . 52  
    *AES67 Unicast Setup*. . . . . 53

**Appendix D: Telos Alliance Limited Warranty . . . . 55**

# Creating the Most Exciting and Engaging Audio Experiences Imaginable

Congratulations on your new Telos Alliance product!

The gang here at Telos is committed to shaping the future of audio by delivering innovative, intuitive solutions that inspire our customers to create the most exciting and engaging audio experiences imaginable.

We're grateful that you have chosen audio tools from Telos® Systems, Omnia® Audio, Axia® Audio, Linear Acoustic®, 25-Seven Systems®, and Minnetonka Audio®. We're here to help you make your work truly shine. We hope that you enjoy your Telos Alliance product for many years to come and won't hesitate to let us know if we can help in any way.

The Telos Alliance



# Chapter One:

## Introducing the xNode

---

xNodes are a family of compact half-rack Livewire audio and logic interfaces with advanced features.

### The xNode family:

- Analog Input/Output xNode: 4 Stereo Analog Line-level Inputs, 4 Stereo Analog Line-level Outputs
- AES/EBU Input/Output xNode: 4 Stereo Digital AES-3 Inputs, 4 Stereo Digital AES-3 Outputs
- Microphone Input/Output xNode: 4 Mic Inputs, 4 Stereo Analog Line-level Outputs
- GPIO Logic xNode: 6 GPIO Ports, each with 5 Opto Inputs and 5 Opto Outputs
- Mixed Signal Input/Output xNode: 1 Mic/Line Analog Input, 2 Analog Line Inputs, 1 AES-3 Input, 3 Analog Line Outputs, 1 AES-3 Output, 2 GPIO Ports, each with 5 inputs and 5 outputs.
- Each of the xNodes support IEEE 802.3af power over Ethernet (PoE) .
- xNodes have a front panel OLED display for setup and status.
- The rear panel contains the audio input/output connectors, the Ethernet connectors and an IEC AC input-connector.
- The xNodes are in small form factor, 1U Half-Rack.
- Two mounting kits are available as options; Surface-mount or Rack-mount.
- Dual 100BT Ethernet ports, usable as mirroring redundant ports or as a single Livewire port and separate management port.
- Thermal sensor monitors temperature and provides notification of over-temp condition.
- IEEE 1588 synchronization support
- Ravenna stream routing support
- Session Announcement Protocol (SAP) support

# The Front Panel



Figure 1-1: xNode Front Panel

The xNode uses the OLED display on the left hand side to provide status information and assist with initial setup.

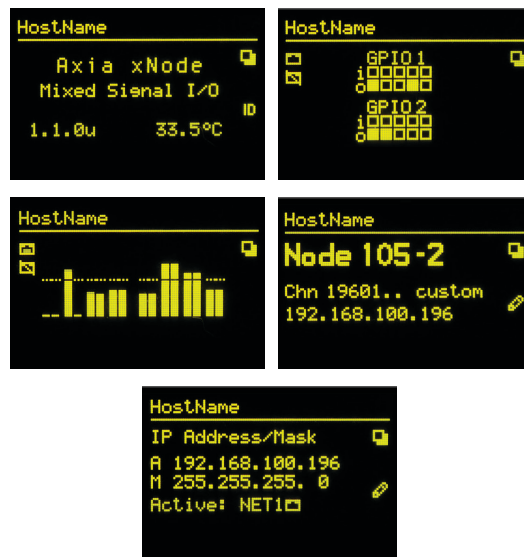

Figure 1-2: xNode OLED Display

## Rear Panel

The rear panel will vary between the xNodes. xNodes will have an IEC connector and two Ethernet ports.

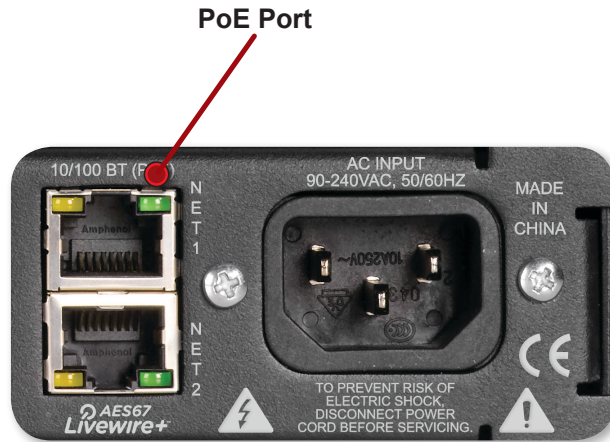

Figure 1-3

The top Ethernet port accepts PoE power and the lower port does not. The remainder of the rear panel will depend on the model of xNode.



### Analog

Four stereo inputs and four stereo outputs are available in parallel through the RJ45 ports or the DB-25 ports. Pinout information is available in **Chapter 4**.



### AES/EBU

Four AES-3 inputs and four AES-3 outputs are available in parallel through the RJ45 ports or the DB-25 ports. Pinout information is available in **Chapter 5**.

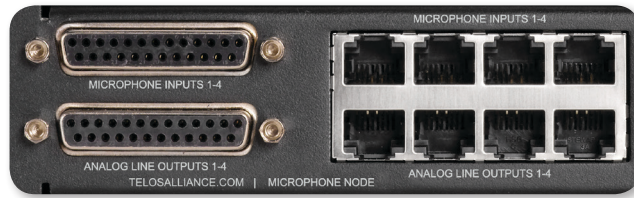

## Microphone

Four Microphone inputs and four stereo analog line-level outputs available on RJ45 or DB-25 connector. Pinout information is available in **Chapter 6**.



## GPIO

6 DA-15 ports, each with 5 Opto Inputs and 5 Opto Outputs. Pinout information is available in **Chapter 7**.

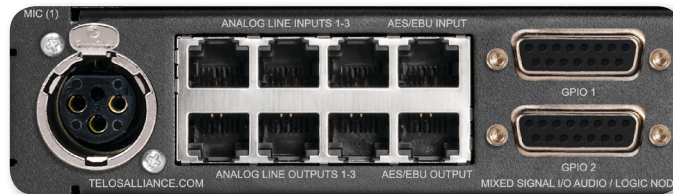

## Mixed Signal

- 1 Mic/Line Analog Input
- 2 Analog Line Inputs
- 1 AES-3 Input
- 3 Analog Line Outputs
- 1 AES-3 Output
- 2 GPIO Ports, each with 5 inputs and 5 outputs.

**Chapter 8** covers pin outs of the mixed xNode.

## HTML Interface

xNodes provide basic configuration from the front panel interface. Further setup or maintenance is available through an HTML interface (otherwise known as a web interface). Accessing this interface requires a PC that is on the same network as the xNode and has an IP address within the same subnet. Using a web browser, the IP address of the xNode is typed into the URL request field. Upon accessing the device, an authentication process is required.

The default username and password are:

**Username: user**

**Password: (none)**

---

### What is meant by subnet?

In this text, the term subnet is used to designate the network portion of an IP address. An IP address, 192.168.1.15, has a network prefix and a host number. Where one ends and the other begins is defined by the subnet mask. A common class C network will have a "netmask" of 255.255.255.0. Compining these two values, 192.168.1.15 255.255.255.0 defines the network prefix (subnet) as 192.168.1 and defines the host number as 15. So two devices within the same subnet would have the same prefix, but required to have different host numbers. 192.168.1.15 and 192.168.1.25 for example.

---

The home page will show system information.

**Node ID:** (shown if ID assigned): An xNode can be assigned an ID which is used to assist with IP addressing and channel numbering.

**Software Version:** The code version which is used by the xNode.

**Temperature:** The temperature reading of the internal sensor. Alarm status will appear if the temperature is above acceptable limits.

**Sync (in audio xNodes):** Indication if the device is receiving sync from the network. A solid SYNC indication represents synchronization with the network.

**Net1 and 2:** Status of the network ports and which is the active port.

**Offline Power and Power Over Ethernet:** Status of power sources.

**System Uptime:** The amount of time since the last bootup.

From the Home page are links to other options. These links are covered in **Chapter 3-8**.

---

Using iProbe will allow a user to see all devices on the network. A left click on a device icon will enable the user to open the configuration user interface (UI). This UI is presented on the screen of iProbe and is the HTML interface as mentioned here. Authentication is the same through iProbe as with a web browser.

---

# Chapter Two:

## Configuration

---

There are different options for how the xNode can be configured; iProbe, assigning an ID to the xNode, or manually configuring the IP address. In the fast setup, we will use the ID method. Following subsections of this chapter will cover the other methods in detail.

### Fast Setup

- Apply power to the xNode and wait for the boot process to complete showing you a home screen identifying the xNode and version.
- Press the top button, the screen button, twice to reach the ID page which shows you a Node ID with no value, Channel numbers 1-8 and no IP address (shown in Figure 2-1)
- Press the second button, pencil icon, for 10 seconds to enter into edit mode.



Figure 2-1

- With the cursor shown, you can use the top button (+) to increment value and the bottom button (▶) to move the cursor to the next position. Press “next” button twice and press the increment button once to give the ID value of 1 to the xNode. (You’ll give a different ID number to each xNode you install.)
- Pressing the move button one additional time completes edit mode and automatically configures the xNode with IP address 10.216.0.101 and channel numbers of 101 – 108.
- That’s actually the end of fast setup! With IP and channel numbers configured, you can attach the xNode to your network and begin connecting sources. But let’s continue on for some quick customization.
- Connect a cross over cable between a computer and the xNode or connect the xNode to the appropriately configured switch.
- Set a static IP address to your computer that has a link to the xNode directly or through a network switch. (an IP address of 10.216.0.100 would be suitable)
- Open a browser and type in the IP address of the xNode (10.216.0.101) into the URL field.
- Default Authentication is:  
**Username: user**  
**Password: (there is no password)**

- Select the Simple Setup button to enter into a simple configuration screen for the xNode. The options available will vary based on the xNode.
- Enter descriptive text in the *Source Name* fields which describe what devices are connected to the xNode (e.g. CD player, Turntable, PC Out-1, Aux Input)
- Enter descriptive text into the *Name* field under the Destination section which documents what is connected to the xNode's outputs (e.g. Control Room Monitors, Headphone, CF Recorder, STL input)

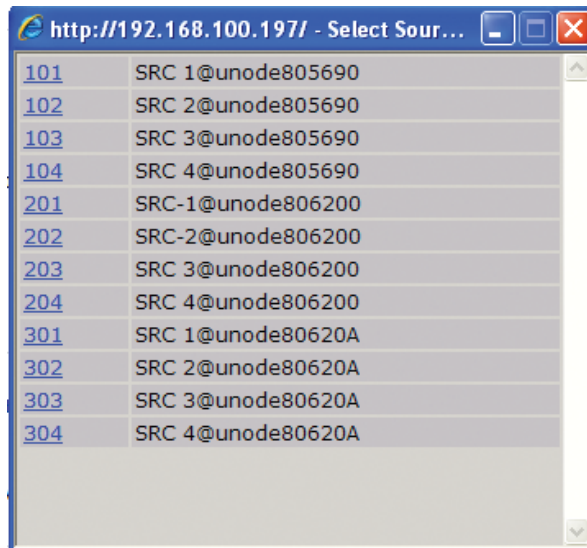

Figure 2-2

- The next step would be to define the audio that is present at the output. This is done by choosing the browse button next the channel text box. A popup will appear with a list of sources that are present on the network. A sample of three xNodes freshly installed into a network is shown in figure 2-2. At this point, not many sources have been configured with valuable descriptive names. Hopefully you see the value of the good practice in using the naming fields. Once you have configured all your xNode sources and other Livewire devices, this browse popup will have more descriptive information which will help you locate the correct source to assign to an output (Destination).

If you notice in figure 2-2, the three xNodes are showing a default host name which provides little assistance to the end user. To resolve this you can select the *System* link under the *Advanced Options* to change the host name to something more descriptive (e.g. Studio1-MICs, TOC-AES1, SATRCK-GPIO1). With a descriptive host name applied to the xNode, a listing of available audio streams will be displayed in a more descriptive manner, i.e., Host-Mic@Studio1-MICs Guest1@Studio1-MICs CD1@Ctrl1-AES WXYZ-tune@TOC-ANA1, etc.

You're done! These steps were designed to get you up and running quickly, but if you need more details on other configuration options, please continue to read this chapter.

For additional information on a particular xNode, look at the following chapters which are dedicated to each model.

## Assigning an IP address manually

If the IP value assigned in the previous steps do not fit within your Livewire network plan or you wish to configure by manual process, you can assign an IP address from the front panel by pressing the page button (top button) until the IP page is shown.

Press and hold the edit button (bottom button) for 10 seconds.

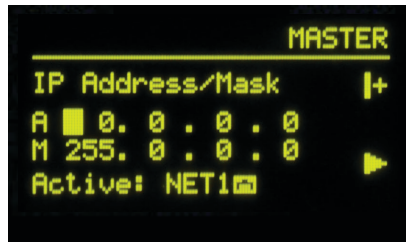

Figure 2-3

A cursor will appear in the Address field. Use the top button to increment and the bottom button to move the cursor to the next position. After 30 seconds of no activity the Edit view will cancel back to the status view. Edit the IP address to your needs. Press the next button (bottom) to move the cursor to the next line which is the Netmask setting. Use the top button to increment the mask to your needs. Press the next button to move to the next line. The NET is highlighted. Pressing the top button will toggle between the two ports allowing you to select which port is active. Press the next button (bottom) one more time to complete the edit process. If the cursor returns to the address field, then an incorrect value has been entered.

---

**NOTE:** You can change the node ID but maintain the same IP address by pressing the increment button when the IP address is highlighted in the Node ID page. This will toggle between a custom address or the new address created through the auto configuration process.

---

Once the xNode has the desired IP value, you can log into the HTML interface with a PC that has a static IP value within the same subnet as the xNode and connected to the same network. Later in this chapter the Simple Setup HTML interface is covered. Each following chapter is dedicated to a specific xNode and covers in detail the HTML pages. .

## Assigning an ID

The method of setting an xNode with an ID was covered in the Fast Setup. Some details of this option were left out. To review the ID method: After the xNode has booted, the title page should show on the OLED display, showing the name of the node and the software version running. The top button acts as the page toggle function. Press the top button until the Node ID page is shown. Press and hold the lower button (represented by the pencil icon) for 10 seconds. A cursor appears following the word Node. Use the top button to increment the cursor value and use the lower button to move to the next position. After 30 seconds of no activity, the edit page will reset back to the status page. Select a unique ID for the xNode. Press the lower button one last time to finalize the edit and return to the status view. The node has now been given an IP address and the inputs have been given unique channel numbers.

---

**MORE ON ID VALUES:** Number ranges of 1-99 (nn) support small-to-medium networks with up to 99 nodes. The node ID determines the IP address (10.216.0.1nn) and the source channel numbers (nn01-nn08).

---

Number ranges of 100-319 (abc) support large networks with up to 2299 nodes. When the 3 digit ID is being used, a second level identifier becomes available with range of d=<0-9>. The node ID determines IP address in range: 10.216.ab.1cd. Channel numbers: abcd1-abcd8.

---



Once the xNode has been assigned an ID value, the device has an IP address that can be used to access its HTML configuration interface. Each input has been assigned a unique Livewire channel number. The next configuration steps are to enter in descriptive names to the inputs and outputs and to assign Livewire sources to the destinations. The Simple Setup page is covered later in the chapter and details of each xNode are available in following chapters.

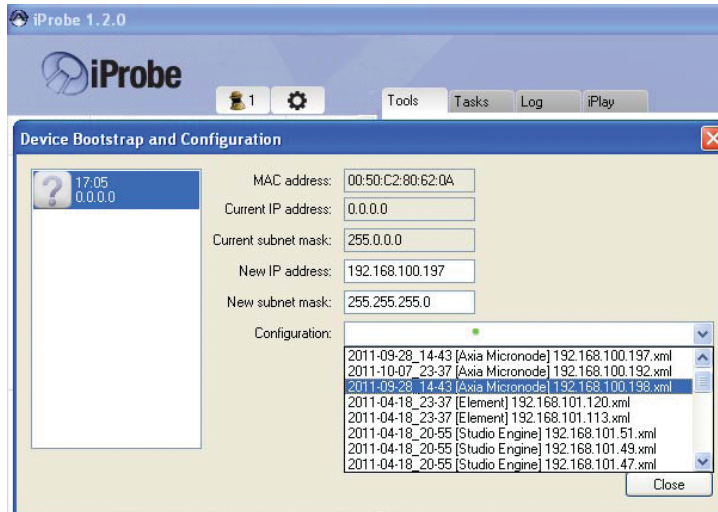



Figure 2-4

## iProbe configuration

When an xNode boots and it has no configuration, it will broadcast a bootp request within 4 seconds. The broadcasts will continue with an increasing delay between messages and randomization until a configuration is set. iProbe includes a bootp function which will observe the request and provide an option to respond or ignore.

A counter at the bootstrap configuration button will appear when a bootp request is received by iProbe (version 1.2). Clicking on the  button will open the Device Bootstrap and Configuration window.

From the window view, select the device that has issued a bootp request. The configuration options will appear allowing you to push a *New IP address*, *New subnet mask*, and a *Configuration*. If you have no backup configuration to send, then apply an IP address and proceed to log into the device through the iProbe interface, and configure it per the “web interface configuration”.

## Web interface configuration (“Simple setup”)

Initially accessing the user interface of the xNode will require authentication. The default authentication is:

**Username:** user

**Password:** (none)

The initial page is the Home page. Select the “Simple setup” button.

The setup page will vary based on what xNode you are configuring. If it is an audio xNode, there will be a section for Sources and a section for Destinations. If GPIO (General Purpose Input/Output) functionality is on the xNode, there will be section for GPIO.

In the Sources section you will provide a name value to help identify the audio source in network advertisements. If a unique ID was assigned to the node, the sources were automatically given channel numbers. Sources are the xNode's audio inputs. These inputs are known within the network as sources and go to Destinations.

Destinations of the xNode are the audio outputs. The Name field is used for documenting what is connected to the audio output port. Channel field is where you select an audio stream from the network to provide audio for the output. If you don't know the channel number, use the browse button immediately to the right to search the network for the desired source. Selecting the source from the pop-up window will populate the channel value of the Destination field.

The GPIO section provides a name field for documenting the purpose of the port. The channel field is used to either enter in another node's IP and port for GPIO routing, or a Livewire channel for Control surface logic. More on this topic is covered in Chapter 7.

## Restoring Defaults

Performing factory reset will clear all configurations and return the xNode to a "blank canvas". To restore default, execute the following steps.

- Disconnect all power from the xNode, then press and hold the two front panel buttons.
- Apply power to the xNode while continuing to press the buttons.
- xNode will show a countdown timer for factory reset. When the timer reaches 0, release the two buttons.

# Chapter Three:

## The xNode in depth

---

This chapter covers details of the xNode family that are shared in common. The xNode is a 1U half-rack device that can be mounted to a flat surface or in an equipment rack with optional accessories.

All xNodes have a common user interface with settings for advanced configuration and maintenance..

### Mounting

#### **Optional Surface Mount kit**

The optional surface mount kit (p/n 2011-00077) consists of two brackets that are used to secure the xNode to a wall, under a desk, or almost any flat surface.

The brackets secure to the side of the xNode, towards the front panel. There are four holes which are used for securing metal work to the xNode.



Figure 3-1

---

Secure the bracket to the xNode with included screws in the desired configuration.



Figure 3-2 Outward configuration

---



Figure 3-3: Inward configuration

---

### Optional Rack Mount kit

The optional rack mount kit (p/n 2011-00076) provides the ability to secure the xNode into an equipment rack.

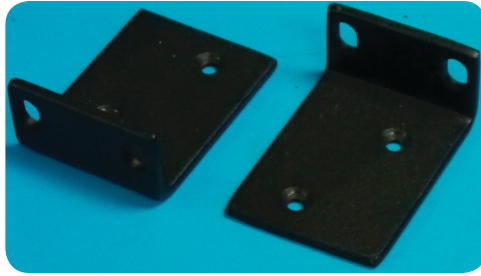

Figure 3-4: Short rack ear

---



Figure 3-5: Long rack ear

---

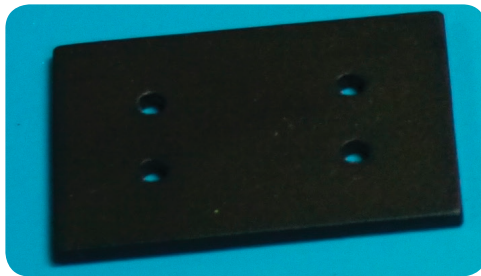

Figure 3-6: Spacer

---

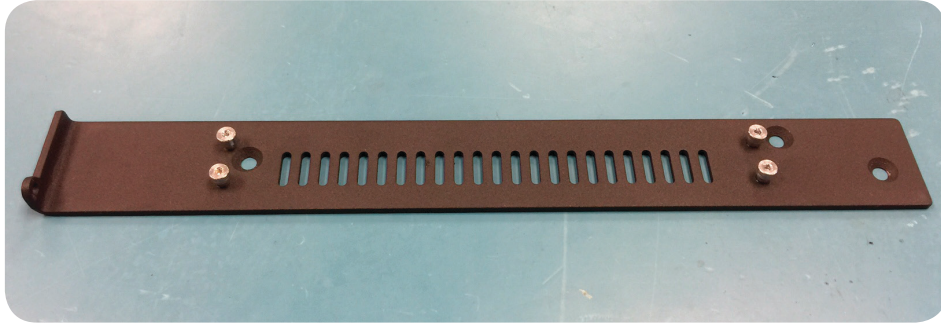

Figure 3-7: Revision 2 "L" bracket (p/n 1771-00128)

### Single xNode

Secure the short rack ear to one side of the xNode.  
Secure the long ear to the opposing side of the xNode.



Figure 3-8

### Double xNode

The method of mounting two xNodes together will depend on the revision of chassis you have. The easy indicator is to identify the keyholes in revision 2

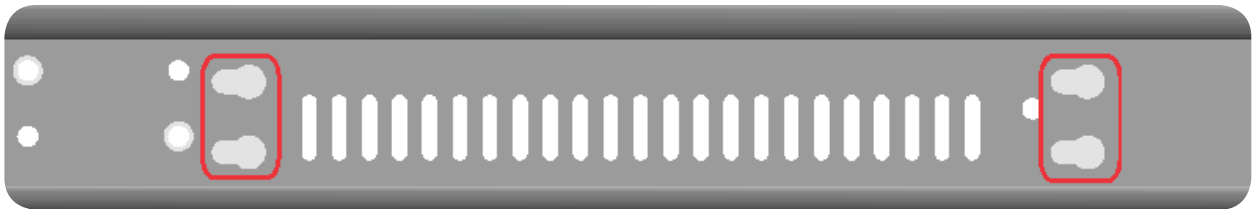

If no keyholes are present on the right side, when looking from the front, please skip to Revision 1 section.

## Revision 2

Secure the provided bracket to an xNode's left side as shown with three provided flat head screws.

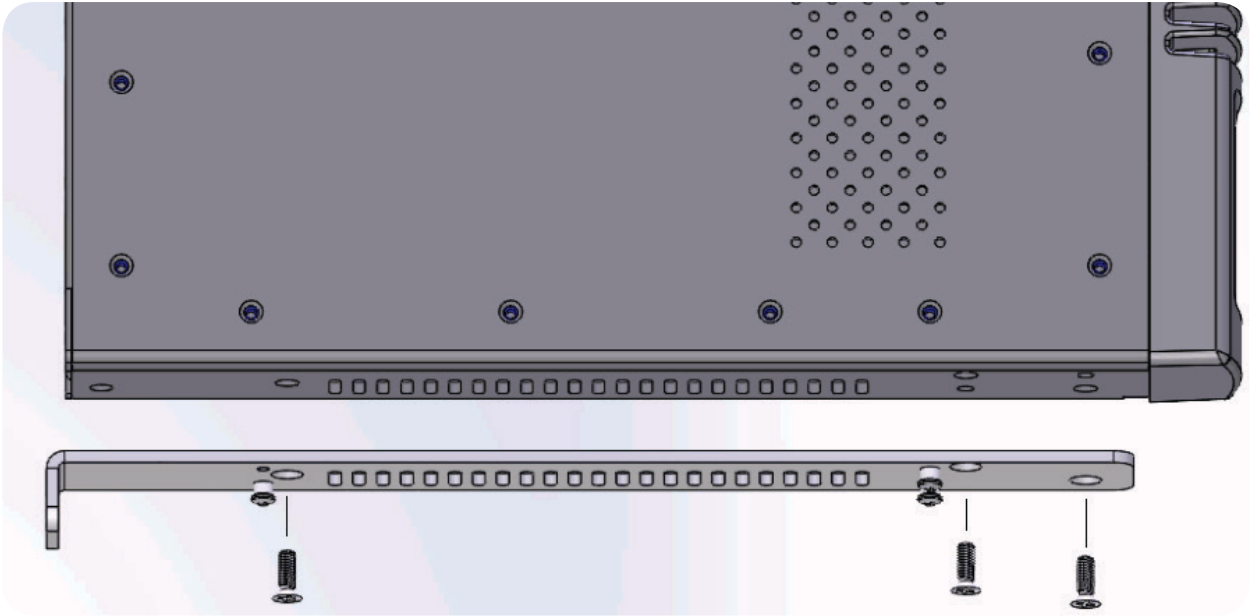

Place the second xNode, so that the shoulder screws of the bracket fit into the keyholes. Slide the xNode into place. **NOTE: The shoulder screws may require adjustment for better fit.**

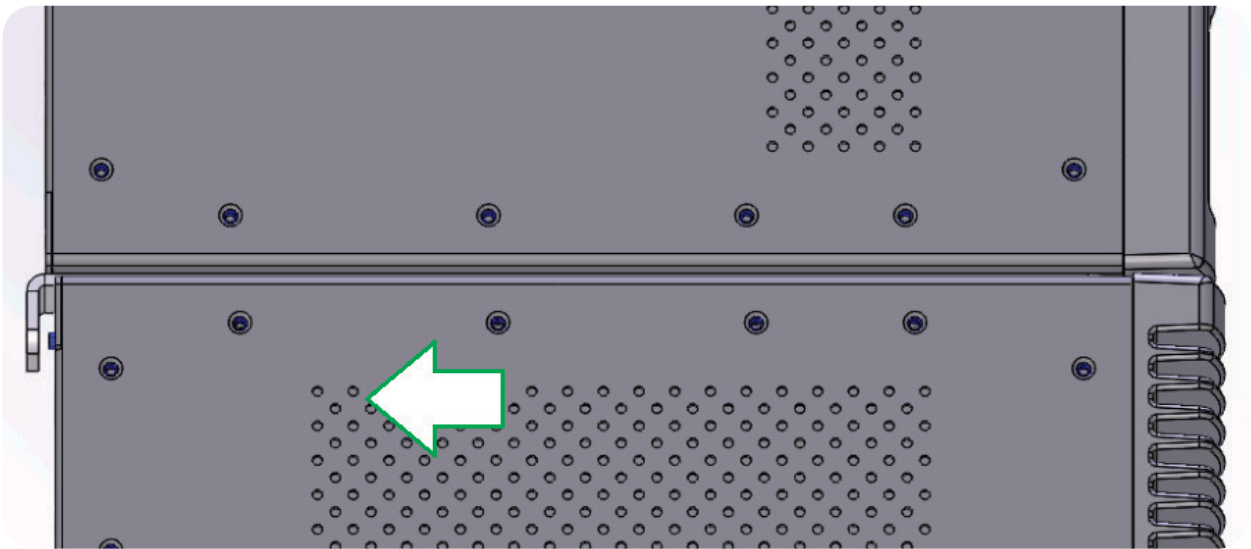

Lock the xNode in place with a screw secured to the back.

## Revision 1

If the keyholes are not present, remove the top lid from both xNodes. Place two xNodes side by side. Place the spacer between the two xNodes.

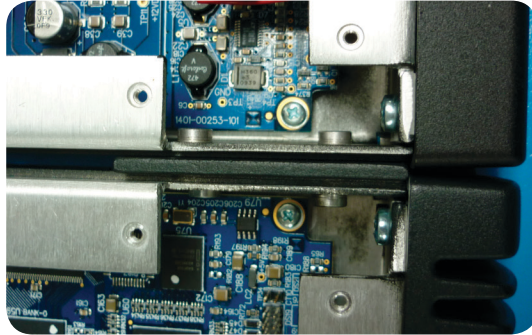

Figure 3-9a

---

Use the four(4) screws provided to secure the two nodes together.

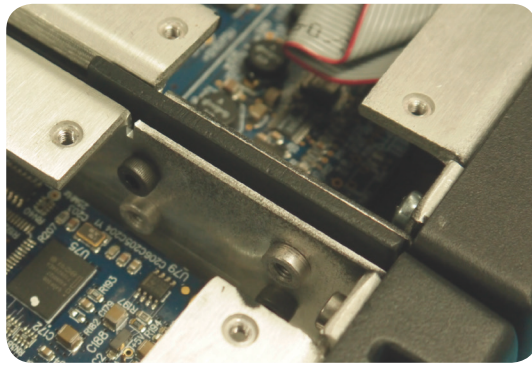

Figure 3-9b

---

Replace the lids on the xNodes. Secure the short rack ears to either side of the two xNodes.



Figure 3-10

---

**Web interface (System options)**

The first time an HTML request is issued to a xNode, a login and password is requested. The default authentication is:

**Username:** user

**Password:** (none)

**Home**

The home page shows system information and acts as the default page for xNodes.

**Node ID** (shown if ID assigned): An xNode can be assigned an ID which is used to assist with IP addressing and channel numbering.

**Software Version:** The code version which is used by the xNode.

**Temperature:** The temperature reading of the internal sensor. Alarm status will appear if the temperature is above acceptable limits.

**Sync** (in audio xNodes): A solid SYNC indication represents synchronization with the network.

**Net1 and Net2:** Shows the status of the xNode's Ethernet ports and indicates which port is active.

**Offline Power and Power Over Ethernet:** Status of power sources.

**System Uptime:** The amount of time since the last boot up.

The Home page also has a button, "Simple Setup", which links to the Simple Setup page.

**Simple Setup**

Simple Setup aggregates all of the xNode's basic config settings on one page, such as ID, source and destination names, GPIO assignments, microphone pre-amp gain, phantom power, and asynchronous options. The top portion of the page shows Node ID settings and would reflect the number applied from the front panel in setup. There are check boxes to permit the enabling of the software to automatically give the device a host name or Livewire channel numbers based on the ID value. Auto channel numbering follows these rules:

- Node ID in range nn=<1-99> - Channel numbers: nn01-nn08.
- Node ID in range abc=<100-319>, with second level identifier d=<0-9> - Channel numbers: abcd1-abcd8.

In audio xNodes there are three radio buttons that control the matrix mixer and general device operation. The Stereo 4x4 or Mono 8x8 options disable the matrix mixer functionality (explained later in this chapter) and configure the device for those modes. The Mix/Custom mode enables the matrix mixer and allows for customization of mono, stereo, and mixing configurations.

The screenshot shows a web interface for the Simple Setup page. It includes a text input field for 'Node ID' containing the number '3', followed by a dropdown menu showing '- 0'. To the right, there are three radio button options: 'Stereo 4x4' (which is selected), 'Mono 8x8', and 'Mix/Custom'. Below these, there is a checkbox labeled 'Use Livewire channels 301 - 308' which is currently unchecked. The interface is separated from the rest of the page by a horizontal dotted line.

Figure 3-11



### **Web interface (Advanced options)**

Advanced options are mainly used in Audio xNodes. The following are the links that are found under the Advanced classification.

## **System**

The System page provides network settings, SNMP settings, Syslog settings, authentication password, and firmware control.

**Host name:** Name of the device on the network. Up to 12 characters using only letters, numbers, or hyphens (no spaces or special characters). Host name is auto populated when you assign an ID to the xNode providing a unique name. You may customize this field if you desire.

**Network address:** The IP address of the device, as configured either manually or via the Setup button or iProbe software. The address can be changed here, but once you apply the changes, you will lose connection and will need to connect to the device with the new IP address you just assigned.

Beginning with software version 1.2, you may configure a management port. By default, NET2 address will be assigned to 0.0.0.0, which defines the second port as a redundant network port. If you'd rather forsake redundancy for a separate management port which does not pass Livewire audio, then set an IP address for the NET2 field, then define which port is the management port and which is the Livewire port.

**Mask:** The netmask is a filter to which helps to define the subnetwork. This is a topic covered in networking material widely available. For simplicity, a value of 255.0.0.0 is a wide open filter and a value of 255.255.255.254 is a very narrow filter. If you are not familiar with how subnetting works, please refer to your network administrator. A value of 255.255.255.0 is usually suitable for most cases.

**Gateway:** The gateway is a device that handles requests and responses from devices that are in different subnets. A gateway is what is needed when dealing with more than a single subnet. If creating a Livewire network on a dedicated local area network (LAN), then the value of the gateway can likely be ignored. If not familiar with the function of gateways, please ask your network administrator.

**Livewire enabled ports:** Default setting is for NET1 and NET2 to be Livewire enabled ports. This provides redundant network ports for audio and control to the same IP address. If you'd rather forsake redundancy to have a separate management port which is removed from the high bandwidth audio traffic, then apply a value to NET2, then select which port is to be Livewire enabled, and which is the management port.

**NTP server:** Specify the sync server if using NTP as the synchronization source. This mode of sync is only good for Standard streams and used for unique applications.

**System location:** Define system location for SNMP

**System contact:** Define system contact for SNMP

**SNMP community name:** Define the community for SNMP functionality

**Syslog server:** IP address of the computer which is running a syslog server application.

**Syslog severity level filter:** The 8 standard syslog levels are available for selection.

**User password:** The authentication password can be changed by entering the password twice in the two fields.

**Firmware version:** The xNode uses two storage banks to store software for the xNode. Switching to a new version of software is done by selecting the other radio button and pressing Apply button.

---

**NOTE** Selecting a new version of software to operate under requires a reboot of the xNode. Rebooting will cause any audio streams to be interrupted until the reboot completes.

---

If Bank 1 is empty, use the Browse function to locate the desired software that has been downloaded to your computer. Once the file is selected, pressing the Apply button will upload the software into the bank. The process will not interrupt the operation of the xNode. Once complete, the System page will return and the two banks will show versions of software.

If operating with Bank 1, and you wish to upload a different version, you will select the “commit this version to Bank 0” and press Apply button. This will move the code to Bank 0 and empty Bank 1.

## QOS (Audio xNodes)

**Synchronization:** Livewire’s clocking system is automatic and largely transparent to end users. If no clock is present on the network, Axia devices negotiate a master by means of priority settings and the lowest MAC address. If a device comes online into a network that has a clock present, it will not generate clock unless it has priority setting of 7. The xNode does permit variance in determining the source of clock.

**Clock mode:** Livewire clock priority 3 (the default setting) is suggested for a typical Livewire network. The higher the priority number given to a node defines the preferred device to become clock master. A value of 7 insists the device becomes master. Livewire STL Snake mode, Master or Slave, are options for applications where a node is at the remote end of an STL link. (Live streams are not supported while in this mode.) If the application is two dedicated nodes at either end of a link, one will be selected to Master and the other to Slave. If the remote node is to connect to a larger network at the studio side, the option to select is Slave—you don’t want the remote node creating clock for the larger facility. PTP/IEEE 1588 ARB clock class 248 is the option to enable the xNode to participate in the execution of the best master clock algorithm for a PTP (Precision Time Protocol) network (enabling it to be a master PTP clock). PTP/IEEE 1588 slave enables the xNode to synchronize to a PTP network. There are various options in the PTP category to allow the node to be a master of both PTP and the Livewire network or to be a slave to a PTP grand master but a master to the Livewire network. This permits the xNode to behave as a gateway of sorts for network synchronization between AES67 devices and legacy Livewire devices. NTP slave is for special applications that synchronize from an NTP source. (Live streams are not supported under NTP mode.)

## PTP characterizations

**PTP domain number:** (0 – 127) A domain is one or more PTP devices communicating with each other. A domain association is used to define communication messages. A value of 0 is standard.

**PTP delay mechanism:** (E2E or P2P) PTP supports two methods of time correction which alter messaging between devices. All devices within the network should use the same mechanism. The recommended setting is to use End-to-End (E2E) since more networked devices prefer to support this option.

**PTP clock priority1/priority2:** Priority setting from 0-255 is used in the best master clock algorithm (BMC) to determine a Grandmaster. Lower numbers have higher priority.

**PTP clock sync interval:** Is the time for sending synchronization messages. A setting of -4 is 16 messages in 1 second. A setting of 1 is 1 message in 2 seconds. The default setting is 0, 1 message per second.

**AES Sync Source:** Used to select the desired input to be utilized as an external clock source. This typically would be used to sync the output ports to a rate different than 48kHz. (Only available on AES/EBU node.)

**AES Output Sync:** Defines the clock for the AES/EBU digital audio output ports (AES/EBU xNode and mixed xNode). The default is to follow the internal 48kHz clock. If an alternate rate is needed, select the other option.

**Master Node Clock Timebase:** The default is to use the internal 48kHz clock present in the xNode for network synchronization. If there is good reason to use an external source, you would select the other option. It is suggested to maintain the default (AES/EBU xNode and mixed xNode).

**Mute AES Output:** An option for turning off the digital AES/EBU stream if no network stream is received.

**Livewire Advertisement Slot:** An option to define a specific time slot in which the node will send advertisement information to the network. The default is 0, random. In extremely large facilities, it is possible for several nodes to randomly become synced in this function. This condition can create jitter issues leading to audio clicks. To resolve this, each device would need a unique slot value. For most facilities, the 0 value will be suitable.

**Enable SAP announcements:** In a yes state enables the xNode to participate in a SAP environment. Session Announcement Protocol (SAP) is used by some other manufactures to advertise their audio sources.

**Live Audio / Clock Streams:** These options define the tagging of the packet for Live Audio and clock. Don't modify these settings unless instructed to do so by Telos Alliance Support.

**AES67 / Standard Audio Streams:** These options define the tagging of the packet for streams that are not the Live Audio streams. These should only be adjusted by personnel that understand the options, or by instruction from Telos Alliance support.

In addition there is a "Standard Stream receive buffer size" which defines the buffer size used for stream reception when the stream is not the Live Stereo type or AES67 type (1 msec).

The AES67 Link Offset defines the buffer used in receiving the 1msec AES67 streams.

### Meters (Audio xNodes)

The meter page uses a Java script to provide real time meter representation of the audio at the inputs and outputs. The meter page shows a stereo channel or a mono channel based on the configuration of the xNode and the amount of channels enabled. The meters are represented in dBFS. Below the meters are gain adjustment buttons which allow for 1dB adjustment (Large button) and 0.1dB adjustment (Small button).

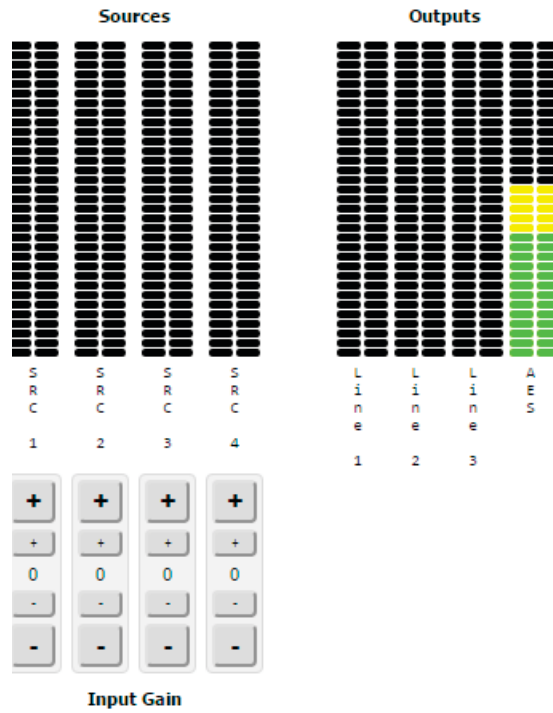

Figure 3-12

### Mixer (Audio xNodes)

Introduced in software version 2.0 is the matrix mixer functionality. The most typical configuration of xNode would be in the Stereo 4x4 mode. In this mode the functionality of the mixer is locked, and the viewer is not able to make any changes. To unlock the functionality, press the “Enable Custom Mode” button found at the top right. Now the viewer can left click a cross point and a pop-up appears for setting the cross point at 0dB (unity gain), setting with a specific gain, or clear the cross point.

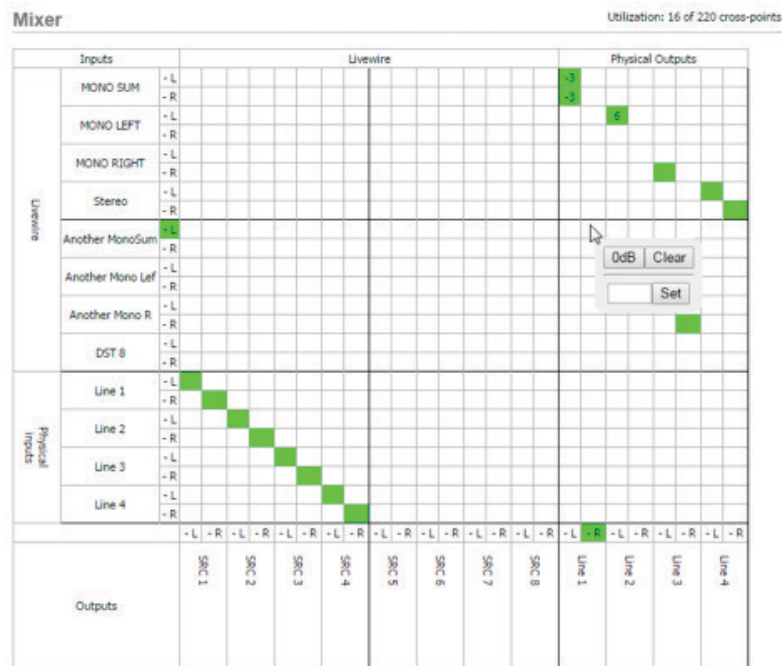

Figure 3-13

The mixer view is organized with inputs into the xNode as rows and outputs from the xNode as columns. Inputs and outputs are composed of physical connections and network streams. In the case of an AES/EBU input on port 1 of the AES/EBU xNode turning into the first network stream source of the xNode, the mixer will show the following view (without the arrows, which are added for clarity).

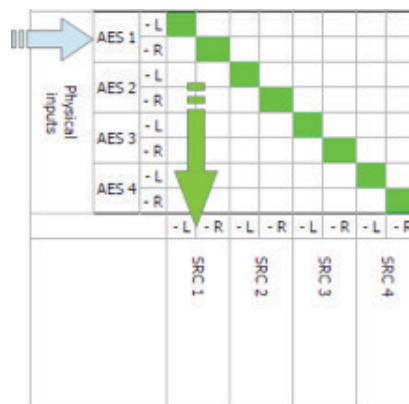

Figure 3-14

Another example with the AES/EBU xNode is all four physical inputs are turned into the first four network stream sources and a fifth network stream source is the sum of three AES/EBU inputs as shown in figure 3-15.



Figure 3-15

Notice that the name of the fifth output is changed, and this is accomplished by entering text into the Source Name field of the Sources page.

The possibilities of what you can achieve with the matrix mixer are quite broad, just keep an eye on the utilization counter present to the top right of the mixer.

### Destinations (Audio xNode)

The Destination page typically defines the audio outputs of the xNode. An xNode has four stereo audio output ports, with the ability to split each stereo channel into two mono outputs. With the introduction of 2.0 software, the Destination page has a new distinction of being more than an xNode outputs view but also a network stream input view. Historically network stream inputs were always turned into physical outputs. With the matrix mixer function mentioned previously, these network stream inputs can be turned into network stream outputs. The Destination page is your view into controlling these network stream inputs. The historical use of network inputs being turned into physical outputs will still be more common, but it is important to point out this new distinction in order for you to understand the mixer functionality of 2.0.

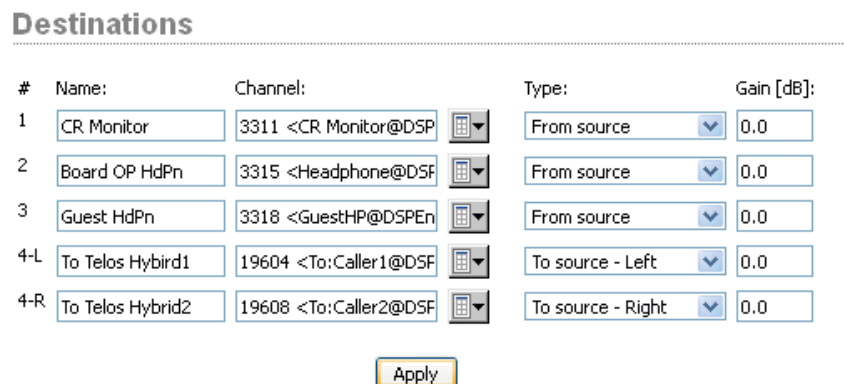

Figure 3-16

The first column is the Name field, used for documenting the physical output or network stream input, which is best labeled as a destination. For example, SpeakerAMP could document that the destination is to the speaker amplifier. The Channel column is used to define the network source being called for to this destination. You may type in the channel number or use the browse button to search the network for the desired source. The Type column defines the stream type that is being called. Livewire stream types are known as “From Source,” “To Source,” or in some cases “Surround.” The “To Source” option is a special dynamic return audio known as a backfeed. A backfeed is a channel automatically generated by Axia consoles for talkback, mix-minus, etc. The Gain column provides adjustment for the destination from the range of -72dB to +24dB.

## Sources (Audio xNode)

The Sources page typically defines the physical audio inputs of the xNode. The corresponding network streams are given a name and a unique channel number that is used to distribute through the network. The xNode provides an auto-numbering process when you ID the xNode through the node ID process described in Chapter 2.

Source Name column is used to identify the physical input or network stream generated by the xNode (for documentation sake) and is also used in source advertisement through the network.

Channel column is the unique number for each source. This will auto-populate based on the ID given to the xNode. It is critical that each source in the network has a unique number, not shared with any other source.

Stream Mode column defines how the audio is packetized. Live stereo is the original Livewire stream intended for microphone or other live audio content that needs a lower delay. A packet contains 12 samples or 250us of audio. Low Latency Stereo is an option for support of Ravenna and AES67 streams. The packet contains 1ms of audio (48 samples). Standard Stereo is the high efficiency stream that contains 240 sample (5ms of audio), maximizing the packet size at 1522 bytes. This option is intended for suitable sources, such as playback machines that can use the higher efficiency with slightly more latency.

Input Gain column provides adjustment of -72dB to +24dB for line level audio and +77dB for microphone audio inputs. When a source is enabled through the stream mode, an RTSP link will appear under the Source row. This link can be given to a media player that supports RTSP as well as 24-bit PCM streaming audio for direct auditioning of the audio stream. VLC 1.1.11, for instance, is a cross-platform media player that supports RTSP. An AES67 SDP stream description is also provided.

### Unicast Link

Unicast Link page allows configuration of multichannel audio link between locations connected with an Ethernet network without support for IP multicasting. In particular it can be used as a studio transmitter link. The page functions as a configuration wizard and applying the settings makes changes in audio routing setup and other options presented on the Sources, Destinations, and QoS pages.

Unicast Link is by default bidirectional. The connection protocol supporting Unicast Link is Real Time Streaming Protocol (RTSP), which is a TCP/IP protocol. Audio is sent using unicast UDP/IP protocol. A basic setup involves setting one xNode to Passive, the first radio button. The second xNode will be configured with the IP address of the remote “Passive” xNode in the “Connect To” field. Connection Status area provides diagnostic information of the established link. When the connection is successful, the icons turn green and Stream active / RTSP OK status is displayed. The Setup interface allow you to save six presets, which can be different remote nodes. Selecting a preset is a fast way of changing the link destination.

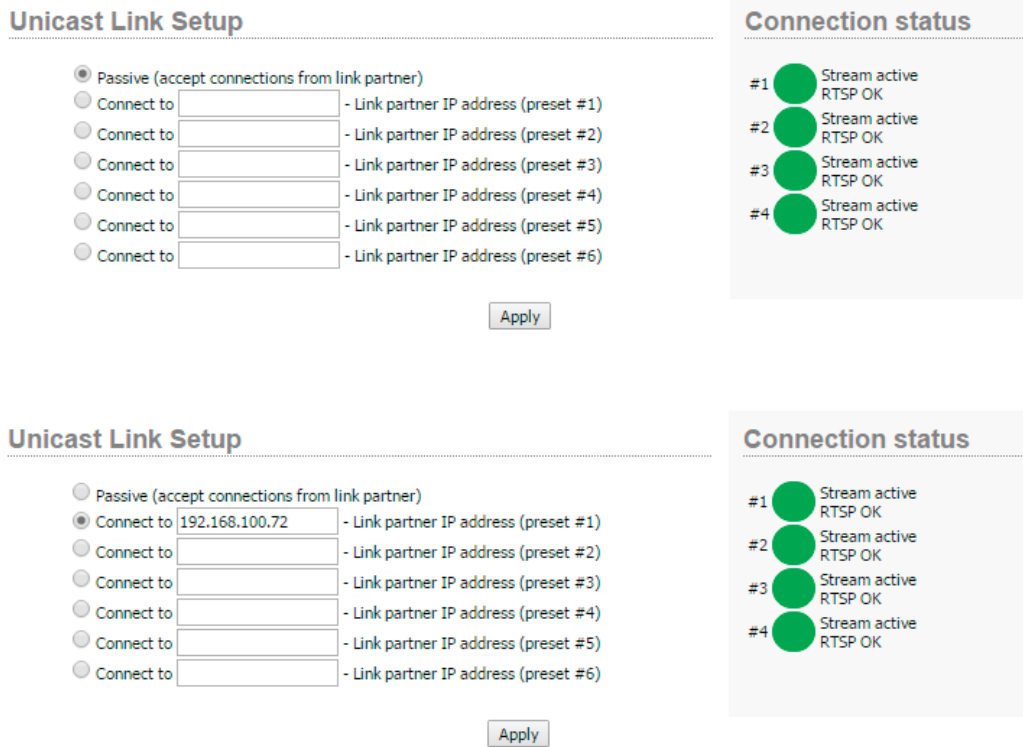

Figure 3-17

If the node is connected to a network with firewall, in order to allow Unicast Link connections, TCP and UDP ports listed on the WEB page need to be configured. The following ports are used:

TCP/554 RFC 2326 Real Time Streaming Protocol (RTSP)

UDP/7000 Livewire synchronization protocol

UDP/16384 Audio RTP stream to destination #1

UDP/16386 Audio RTP stream to destination #2

UDP/16388 Audio RTP stream to destination #3

UDP/16390 Audio RTP stream to destination #4

The basic setup establishes four bidirectional streams. If the needs are for less audio links, bandwidth utilization can be reduced if the settings are customized. This is done by disabling unused channels through the Source page. The setup wizard mention above would have set all source streams to standard stereo.

In Unicast Mode, the front panel presents the link status information as triangles below the meters.

- If no triangle is shown, the Source and Destination port is not configured for Unicast.
- If the triangle is blinking, the port is configured for Unicast, but there is no active connection.
- When the triangle is displayed solid on, there is a Unicast Link established to that port.



# Chapter Four:

## Analog xNode

There are 4 two-channel (8 one-channel) inputs with the analog xNode. With default settings, the xNode will generate 4 Livewire stereo sources. You may also configure the inputs separately as different sources and generate up to 8 Livewire mono sources.

### Rear Panel

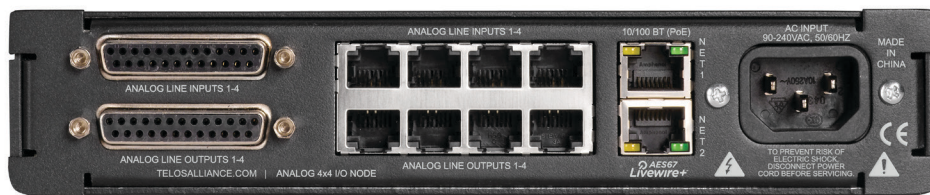

Figure 4-1: Analog xNode Rear Panel

The analog xNode uses RJ45 style connectors and 25 pin D-sub connectors for audio I/O, providing an option to either use standard CAT5e patch cables or D-Sub breakout cables for audio wiring.

The top 4 RJ-45 style ports are line level analog inputs. The bottom 4 RJ-45 style ports are line level analog outputs.

#### The pinout of an RJ-45 port

PIN	FUNCTION
1	Left Channel Input/Output +
2	Left Channel Input/Output -
3	Right Channel Input/Output +
4	Ground
5	Not Used
6	Right Channel Input/Output -
7	Not Used
8	Not Used

The pinout of the DB-25 connector follows established Pro Audio conventions. Breakout cables can be acquired from your audio supply company.

### ***The pinout of the DB-25***

<b>PIN</b>	<b>FUNCTION</b>
1	Channel 4b/8 +
2	Channel 4b/8 Gnd
3	Channel 4a/7 -
4	Channel 3b/6 +
5	Channel 3b/6 Gnd
6	Channel 3a/5 -
7	Channel 2b/4 +
8	Channel 2b/4 Gnd
9	Channel 2a/3 -
10	Channel 1b/2 +
11	Channel 1b/2 Gnd
12	Channel 1a/1 -
13	not used
14	Channel 4b/8 -
15	Channel 4a/7 +
16	Channel 4a/7 Gnd
17	Channel 3b/6 -
18	Channel 3a/5 +
19	Channel 3a/5 Gnd
20	Channel 2b/4 -
21	Channel 2a/3 +
22	Channel 2a/3 Gnd
23	Channel 1b/2 -
24	Channel 1a/1 +
25	Channel 1a/1 Gnd

# Chapter Five:

## AES xNode

The AES xNode provides four inputs. By default this will generate 4 Livewire stereo sources. You may also separate the 2 channel AES inputs as different sources and generate up to 8 Livewire dual mono sources.

The AES xNode provides four AES outputs. By default the outputs will be an AES stream based on a single Livewire stream. The option is available to create an AES stream (Left and Right) which is composed from two different Livewire streams.

### Rear Panel

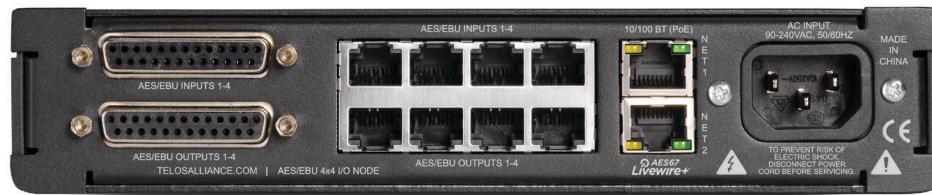

Figure 5-1: AES xNode Rear Panel

The AES xNode uses RJ45 style connectors and 25 pin D-sub connectors for audio I/O, providing an option to either use standard CAT5e patch cables or D-Sub connector breakout cables for audio wiring.

The top 4 RJ-45 style ports are AES/EBU inputs. The bottom 4 RJ-45 style ports are AES/EBU outputs.

#### The pinout of an RJ-45 port

PIN	FUNCTION
1	AES Input/Output +
2	AES Input/Output -
3	Not Used
4	Not Used
5	Not Used
6	Not Used
7	Not Used
8	Not Used

### The pinout of the DB-25

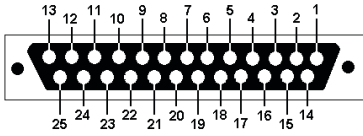

PIN	FUNCTION
1	Not Used
2	Not Used
3	Not Used
4	Not Used
5	Not Used
6	Not Used
7	AES Ch4 +
8	AES Ch4 Gnd
9	AES Ch3 -
10	AES Ch2 +
11	AES Ch2 Gnd
12	AES Ch1 -
13	Not Used
14	Not Used
15	Not Used
16	Not Used
17	Not Used
18	Not Used
19	Not Used
20	AES Ch4 -
21	AES Ch3 +
22	AES Ch3 Gnd
23	AES Ch2 -
24	AES Ch1 +
25	AES Ch1 Gnd

# Chapter Six:

## Microphone xNode

---

The microphone xNode has four mono inputs. The Simple Setup page has options to set the microphone pre-amp gain.

The microphone xNode provides four analog 2-channel outputs, line level. By default the outputs will be stereo audio from an audio source from the network. This may be configured differently so that the 2 channel analog output delivers two mono streams.

### Rear Panel

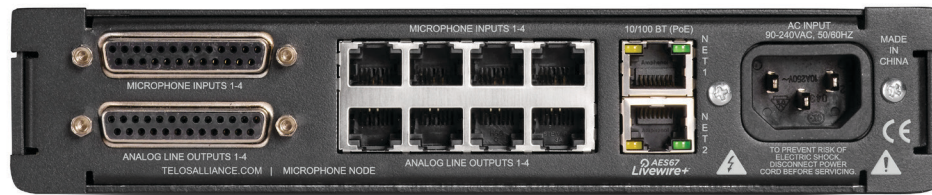

Figure 6-1: Microphone xNode Rear Panel

The microphone xNode uses RJ45 style connectors and 25 pin D-sub connectors for audio I/O, providing an option to either use patch cables or breakout cables for audio wiring to either use standard CAT5e patch cables or D-Sub connector breakout cables for audio wiring.

The top 4 RJ-45 style ports are analog, mono inputs. The bottom 4 RJ-45 style ports are line level analog outputs.

#### **The pinout of an RJ-45 port**

PIN	FUNCTION
1	MIC +
2	MIC -
3	Not Used
4	Ground
5	Not Used
6	Not Used
7	Not Used
8	Not Used
shld	GND

### The pinout of the DB-25

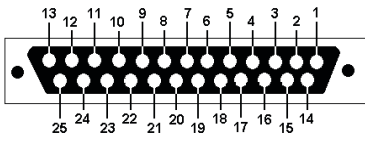

### (Microphone Inputs 1-4)

PIN	FUNCTION
1	Not Used
2	Not Used
3	MIC Ch4 -
4	Not Used
5	Not Used
6	MIC Ch3 -
7	Not Used
8	Not Used
9	MIC Ch2 -
10	Not Used
11	Not Used
12	MIC Ch1 -
13	Not Used
14	Not Used
15	MIC Ch4 +
16	MIC Ch4 Gnd
17	Not Used
18	MIC Ch3 +
19	MIC Ch3 Gnd
20	Not Used
21	MIC Ch2 +
22	MIC Ch2 Gnd
23	Not Used
24	MIC Ch1 +
25	MIC Ch1 Gnd

**(Analog Line Outputs 1-4)**

PIN	FUNCTION
1	Channel 4b/8 +
2	Channel 4b/8 Gnd
3	Channel 4a/7 -
4	Channel 3b/6 +
5	Channel 3b/6 Gnd
6	Channel 3a/5 -
7	Channel 2b/4 +
8	Channel 2b/4 Gnd
9	Channel 2a/3 -
10	Channel 1b/2 +
11	Channel 1b/2 Gnd
12	Channel 1a/1 -
13	Not Used
14	Channel 4b/8 -
15	Channel 4a/7 +
16	Channel 4a/7 Gnd
17	Channel 3b/6 -
18	Channel 3a/5 +
19	Channel 3a/5 Gnd
20	Channel 2b/4 -
21	Channel 2a/3 +
22	Channel 2a/3 Gnd
23	Channel 1b/2 -
24	Channel 1a/1 +
25	Channel 1a/1 Gnd

# Chapter Seven:

## GPIO xNode

The GPIO xNode provides 6 DA-15 ports. Each port provides 5 GPI (opto isolated inputs) and 5 GPO (solid state relays). Each port is capable of driving a combined current of 100mA. Each GPI pin should be limited to 20mA of current.

The web interface provides configuration control as well as a real time view on each of the GPI and GPO pins through a Java script in the web interface.

### Rear Panel



Figure 7-1: GPIO xNode Rear Panel

The illustration below shows the connector pinouts; 5 inputs and associated common return, 5 output relays and associated common, a +5 volt power source, and power source ground.

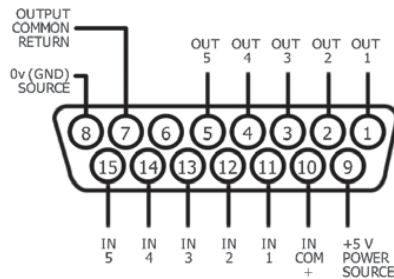

Figure 7-2



The maximum allowed external power supply for logic control is 48 volts DC. The use of current limiting resistor is required for some voltages.

INPUT	
VDC	External Series Resistor
5	0
6	0
12	680 @ 1/4 watt
24	1.8k @ 1/2 watt
48	3.9k @ 1 watt

Using external power supplies is the recommended method in order to avoid possible ground loops between equipment.

Take note to use current limiting resistors per Figure: 7-3 if the voltage supplied is above 6vdc. The intention is to limit the current to 20mA for each GPI pin. If the equipment being controlled is electrically isolated, than the use of the GPIO port's power supply is acceptable.

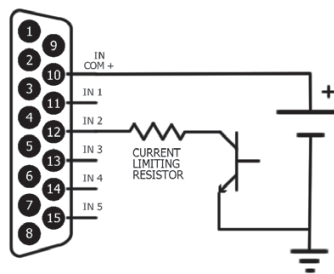

Figure 7-3

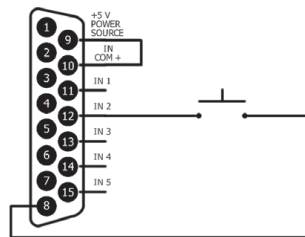

Figure 7-4

Telos Alliance GPIO accessory modules are designed to interface directly to the GPIO port. The DA-15 connector on the back of an accessory module is a direct pin-to-pin match to the GPIO port of the xNode. Premade cables of this configuration are commonly available through companies that specialize in interconnect cable assembly products.

The GPO portion of the GPIO ports are solid state relays. Current should be limited to a combined 100 mA through all the pins of a port. Maximum allowed voltage is 24 volts. The following diagram shows the recommended connections for outputs with the use of an external power supply.

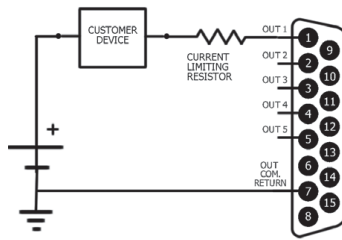

Figure 7-5

If the device being controlled is electrically isolated, than the 5vDC supply can be used, maintaining a 100mA limit on current drawn.

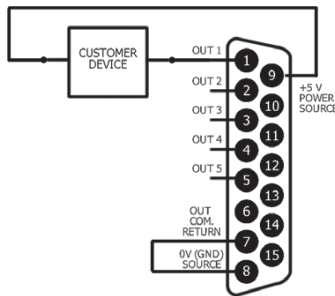

Figure 7-6

The Telos Alliance accessory modules use the 5vDC supply to illuminate LED based buttons. So a one-to-one pin connection is all that is needed between any accessory modules and a GPIO port.

Note that all of the inputs and outputs on a specific GPIO port are “grouped together”. The 5 “Outputs” are on 5 separate output pins, however, they share the same “Common Return” connection on Pin #7. Similarly, the 5 “Inputs” pins would be pulled to ground to activate them, and they share a common pin for a high-side rail, on Pin #10. If more than one remotely-controlled device is to be connected to a single 15-pin I/O port, you must make sure that the two units in question have the same ground potential or ground loops will occur. Therefore, it is recommended that only one remote device be connected to each I/O port connector to assure complete electrical isolation.

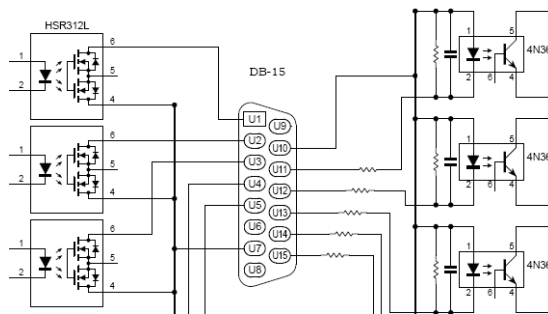

Figure 7-7

**Tid bit of worthless knowledge:** The D-sub series of connectors was invented by ITT Corporation, in 1952. Cannon’s part-numbering system uses D as the prefix for the whole series, followed by one of A, B, C, D, or E denoting the shell size, followed by the number of pins. Each shell size usually corresponds to a certain number of pins: A with 15, B with 25, C with 37, D with 50, and E with 9. For example, DB25 denotes a D-sub with a 25position shell size and a 25-position contact configuration which was common in the onset of personal computers. When the PC serial port transitioned to the use of a 9-pin connector, they were often labeled as DB9 instead of DE9 connectors, due to an ignorance of the fact that B represented a shell size. It is now common to see DE9 connectors sold as DB9 connectors.

## Simple Setup

The GPIO xNode has a simple setup page which provides access to the node ID (a node ID was likely already assigned from the front panel at install) and configuration of the 6 GPIO ports. Included also in the page is a Java script which provides status on each of the inputs and outputs.

Node ID:  -

### GPIO

#	Name:	Channel:		Inputs	Outputs
1	<input type="text" value="GPIO 1"/>	<input type="text" value="127.0.0.1/1"/>	<input type="button" value="v"/>	<input type="checkbox"/>	<input type="checkbox"/>
2	<input type="text" value="GPIO 2"/>	<input type="text" value="127.0.0.1/2"/>	<input type="button" value="v"/>	<input checked="" type="checkbox"/>	<input checked="" type="checkbox"/>
3	<input type="text" value="GPIO 3"/>	<input type="text" value="127.0.0.1/3"/>	<input type="button" value="v"/>	<input type="checkbox"/>	<input type="checkbox"/>
4	<input type="text" value="GPIO 4"/>	<input type="text" value="127.0.0.1/4"/>	<input type="button" value="v"/>	<input type="checkbox"/>	<input type="checkbox"/>
5	<input type="text" value="GPIO 5"/>	<input type="text" value="127.0.0.1/5"/>	<input type="button" value="v"/>	<input type="checkbox"/>	<input type="checkbox"/>
6	<input type="text" value="GPIO 6"/>	<input type="text" value="127.0.0.1/6"/>	<input type="button" value="v"/>	<input type="checkbox"/>	<input type="checkbox"/>

Figure 7-8

Each port is represented by a row. The name column is used to assist with documenting the function of the port (or the device which is connected to the port). The Channel column is used to configure the port. The input and output columns show a grouping of boxes that represent each of the 5 GPIs and 5 GPOs. A high state (not active) is represented by a black box. A low state (active) is represented by a green state.

Configuration of a port can be accomplished in three different ways.

1. **Port routing** – The GPI activity on a port will trigger the GPO of the port you are configuring. (you are routing the GPIs of a port to another port's GPOs). This is done by entering in the IP address of the device with a GPIO port followed by a forward slash and the port number. 10.216.0.121/5 – equates to port 5 at address 10.216.0.121 new line 127.0.0.1/1 assigned to port 1 would be a loopback; GPI activity on the port would trigger the GPO of the same port (used for testing)
2. **Channel assignment** – The GPIO port will follow the logic as defined by a control surface. Axia control surfaces have predefined logic for a source loaded to a fader. The logic is shared on the network through the use of the unique channel number for a source. Refer to appendix A for common predefined functions. To assign a port to a channel, either manually type in the channel number in the field OR use the browse button to search the network for advertised sources.
3. **Pathfinder control** – The Pathfinder series of products has the ability to observe GPIO activity as well as trigger GPO activity. Nothing is required to configure in the GPIO xNode, all the configuration is done in Pathfinder. Please refer to Pathfinder documentation for detailed information.

## Other Web Interfaces

The GPIO xNode does not have any complexity to it, so there are no advance web pages to worry about.

### Home

The Home page is the default page and provides information on the device ID, software version, system temp, network interface status, power supply status, and uptime. There is no sync information as in other xNodes because the GPIO xNode is not an audio device and therefore does not require audio synchronization.

### System

The system page provides access to IP settings, logging options, password change, and software control. The system page is covered in more detail in chapter 3, section Web Interface.

# Chapter Eight:

## Mixed Signal xNode

The Mixed Signal xNode has one microphone, three analog stereo inputs, one AES/EBU input, three analog stereo outputs, one AES/EBU output, and 2 GPIO ports (5GPI/5GPO per port). The single microphone pre-amp gain is set on the simple setup page.

### Rear Panel

The Mixed Signal xNode uses RJ45 connectors for analog and AES audio, and an XLR connector for the selectable Mic input.

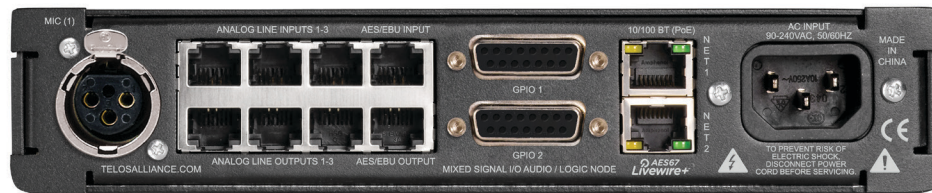

Figure 8-1: Mixed Signal xNode Rear Panel

The top 4 RJ-45 style ports are inputs; three analog inputs followed by one AES/EBU input. The bottom 4 RJ-45 style ports are outputs; three analog outputs followed by one AES/EBU output.

The XLR-F connector is used as an analog input with the intention of it being a microphone input.

PIN	FUNCTION
1	Shield
2	Positive
3	Negative

### The pinout of an RJ-45 port

PIN	FUNCTION
1	Left Channel /AES Input/Output +
2	Left Channel /AES Input/Output -
3	Right Channel Input/Output +
4	Ground
5	Not Used
6	Right Channel Input/Output -
7	Not Used
8	Not Used

The illustration shows the connector pinouts; 5 inputs and associated common return, 5 output relays and associated common, a +5 volt power source, and power source ground.

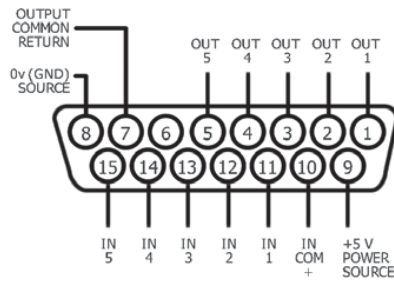

Figure 8-2

**The maximum allowed external power supply for logic control is 48 volts DC. The use of current limiting resistor is required for some voltages.**

INPUT	
VDC	External Series Resistor
5	0
6	0
12	680 @ 1/4 watt
24	1.8k @ 1/2 watt
48	3.9k @ 1 watt

Using external power supplies is the recommended method to avoid possible ground loops between equipment.

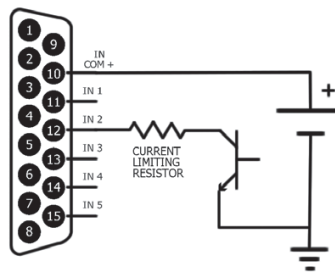

Figure 8-3

Take note to use current limiting resistors per the above chart if the voltage supplied is above 6vdc. The intention is to limit the current to 20mA for each GPI pin. If the equipment being controlled is electrically isolated, than the use of the GPIO port's power supply is acceptable.

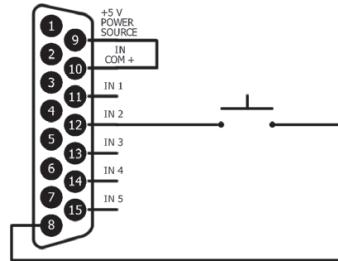

Figure 8-4

Telos Alliance GPIO accessory modules are designed to interface directly to the GPIO port. The DA-15 connector on the back of an accessory module is a direct pin-to-pin match to the GPIO port of the xNode. Premade cables of this configuration are commonly available through companies that specialize in interconnect cable assembly products.

The GPO portion of the GPIO ports are solid state relays. Current should be limited to a combined 100 mA through all the pins of a port. The following diagram shows the recommended connections for outputs with the use of an external power supply.

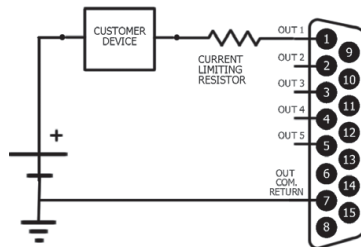

Figure 8-5

If the device being controlled is electrically isolated, than the 5vDC supply can be used, maintaining a 100mA limit on current drawn.

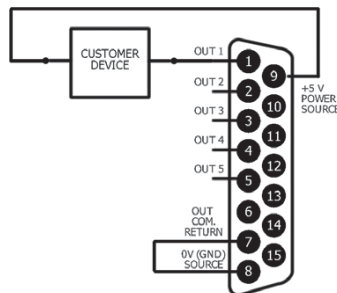

Figure 8-6

The Telos Alliance accessory modules use the 5vDC supply to illuminate LED based buttons. So a one-to-one pin connection is all that is needed between any accessory modules and a GPIO port.

Note, all of the inputs and outputs on a specific GPIO port are “grouped together”. The 5 “Outputs” are on 5 separate output pins, however, they share the same “Common Return” connection on Pin #7. Similarly, the 5 “Inputs” pins would be pulled to ground to activate them, and they share a common pin for a high-side rail, on Pin #10. If more than one remotely-controlled device is to be connected to a single 15-pin I/O port, you must make sure that the two units in question have the same ground potential or ground loops will occur. Therefore, it is recommended that only one remote device be connected to each I/O port connector to assure complete electrical isolation.

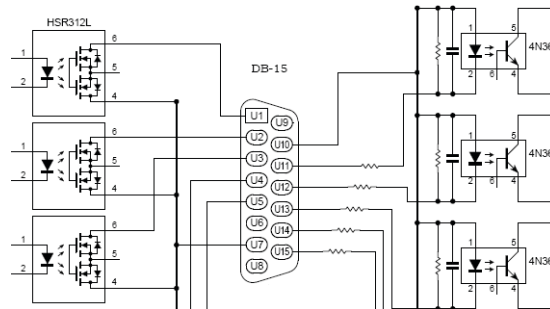

Figure 8-7

## Simple Setup

Simple Setup page provides the only configuration access to the two GPIO ports. Each port is represented by a row. The name column is used to assist with documenting the function of the port (or the device which is connected to the port). The Channel column is used to configure the port. The input and output columns show a grouping of boxes that represent each of the 5 GPIs and 5 GPOs. A high state (not active) is represented by a black box. A low state (active) is represented by a green state.

Configuration of a port can be accomplished in three different ways.

1. **Port routing** – The GPI activity on a port will trigger the GPO of the port you are configuring. (you are routing the GPIs of a port to another port’s GPOs). This is done by entering in the IP address of the device with a GPIO port followed by a forward slash and the port number. 10.216.0.121/5 – equates to port 5 at address 10.216.0.121 127.0.0.1/1 assigned to port 1 would be a loopback; GPI activity on the port would trigger the GPO of the same port (used for testing)
2. **Channel assignment** – The GPIO port will follow the logic as defined by a control surface. Axia control surfaces have predefined logic for a source loaded to a fader. The logic is shared on the network through the use of the unique channel number for a source. Refer to Appendix A for common predefined functions. Refer to the control surface manual for updated information on these functions. To assign a port to a channel, either manually type in the channel number in the field OR use the browse button to search the network for advertised sources.
3. **Pathfinder control** – The Pathfinder series of products has the ability to observe GPIO activity as well as trigger GPO activity. Nothing is required to configure in the GPIO xNode, all the configuration is done in Pathfinder. Please refer to Pathfinder documentation for detailed information.

Any manual entries made into fields will require you to save the work by pressing the APPLY button.



# Appendix A:

## GPIO Logic Table Samples

### GPIO Operator's Microphone Logic

Name	Pin	Type	Notes
<b>INPUTS</b>			
ON Command	11	Active Low Input	Turns channel ON
OFF Command	12	Active Low Input	Turn channel OFF
TALK (to Monitor 2) Command	13	Active Low Input	Activates the TALK TO MON2 function and routes mic audio to the Talkback bus.
MUTE Command	14	Active Low Input	Mutes channel outputs
TALK (to PREVIEWED SOURCE) Command	15	Active Low Input	Activates the TALK button on every source currently in preview and routes mic audio to the Talkback bus.
<b>OUTPUTS</b>			
ON Lamp	1	Open Collector to Logic Common Return	Illuminates when channel is ON unless TALK or MUTE is active
OFF Lamp	2	Open Collector to Logic Common Return	Illuminates when channel is OFF
TALK (to Monitor 2) Lamp	3	Open Collector to Logic Common Return	Illuminates when TALK TO MON2 is active
MUTE Lamp	4	Open Collector to Logic Common Return	Illuminates when MUTE is active
TALK (to PREVIEWED SOURCE) Lamp	5	Open Collector to Logic Common Return	Illuminates when TALK to PREVIEWED SOURCE is active.
<b>POWER &amp; COMMON</b>			
Source Common	7	Logic Common	Connect to ground of source device or to Pin 8
Logic Common	8	Internal 5 Volt return	Can be connected to Pin 7 if source is not providing common
Logic +5 Volt Supply	9	Logic Supply, Individually Fused	Can be connected to Pin 10 if source is not providing voltage; active only when source has been assigned to channel.
Input Common	10	Common for all 5 inputs	Connect to power supply of source device or to Pin 9
NOT CONNECTED	6		

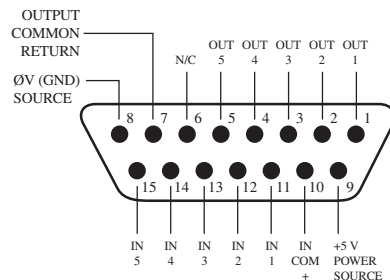

GPIO v. "ZA" 4/2009

## GPIO Control Room Guest Microphone Logic

Name	Pin	Type	Notes
<b>INPUTS</b>			
ON Command	11	Active Low Input	Turns channel ON
OFF Command	12	Active Low Input	Turn channel OFF
TALK (to CR) Command	13	Active Low Input	Mutes channel outputs and routes source audio to PVW speakers
MUTE Command	14	Active Low Input	Mutes channel outputs
NOT CONNECTED	15		
<b>OUTPUTS</b>			
ON Lamp	1	Open Collector to Logic Common Return	Illuminates when channel is ON unless TALK or MUTE is active
OFF Lamp	2	Open Collector to Logic Common Return	Illuminates when channel is OFF
TALK (to CR) Lamp	3	Open Collector to Logic Common Return	Illuminates when TALK is active
MUTE Lamp	4	Open Collector to Logic Common Return	Illuminates when MUTE is active
NOT CONNECTED	5		
<b>POWER &amp; COMMON</b>			
Source Common	7	Logic Common	Connect to ground of source device or to Pin 8
Logic Common	8	Internal 5 Volt return	Can be connected to Pin 7 if source is not providing common
Logic + 5 Volt supply	9	Logic Supply, Individually Fused	Can be connected to Pin 10 if source is not providing voltage; active only when source has been assigned to channel.
Source Supply	10	Common for all 5 inputs	Connect to power supply of source device or to Pin 9
NOT CONNECTED	6		

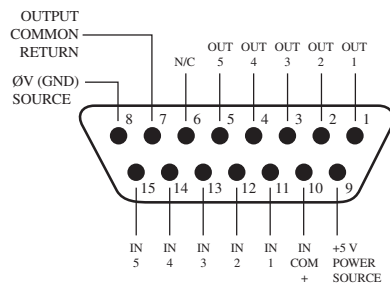

## GPIO Producer's Microphone Logic

Name	Pin	Type	Notes
<b>INPUTS</b>			
ON Command	11	Active Low Input	Turns channel ON
OFF Command	12	Active Low Input	Turn channel OFF
TALK (to MONITOR 2) Command	13	Active Low Input	Activates the TALK to MON2 function and routes mic audio to the Talkback bus.
MUTE Command	14	Active Low Input	Mutes channel outputs
TALK (to PREVIEWED SOURCE) Command	15	Active Low Input	Activates the TALK button on every source currently in Preview and routes mic audio to the Talkback bus.
<b>OUTPUTS</b>			
ON Lamp	1	Open Collector to Logic Common Return	Illuminates when channel is ON unless TALK or MUTE is active
OFF Lamp	2	Open Collector to Logic Common Return	Illuminates when channel is OFF
TALK (to MONITOR 2) Lamp	3	Open Collector to Logic Common Return	Illuminates when TALK to MON2 is active.
MUTE Lamp	4	Open Collector to Logic Common Return	Illuminates when MUTE is active
TALK (to PREVIEWED SOURCE) Lamp	5	Open Collector to Logic Common Return	Illuminates when TALK to PREVIEWED SOURCE is active.
<b>POWER &amp; COMMON</b>			
Source Common	7	Logic Common	Connect to ground of source device or to Pin 8
Logic Common	8	Internal 5 Volt return	Can be connected to Pin 7 if source is not providing common
Logic + 5 Volt supply	9	Logic Supply, Individually Fused	Can be connected to Pin 10 if source is not providing voltage; active only when source has been assigned to channel.
Source Supply	10	Common for all 5 inputs	Connect to power supply of source device or to Pin 9
NOT CONNECTED	6		

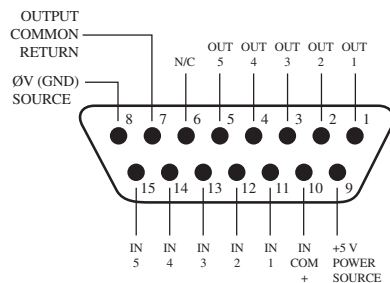

## GPIO Line Input Logic

Name	Pin	Type	Notes
<b>INPUTS</b>			
ON Command	11	Active Low Input	Turns channel ON
OFF Command	12	Active Low Input	Turns channel OFF & sends 100 msec STOP pulse
PREVIEW Command	13	Active Low Input	Turns preview ON
RESET Command	14	Active Low Input	Turns channel OFF, while not sending a STOP pulse
READY Command	15	Active Low Input	Illuminates OFF lamp to indicate source's readiness
<b>OUTPUTS</b>			
ON Lamp	1	Open Collector to Logic Common Return	Illuminates when channel is ON
OFF Lamp	2	Open Collector to Logic Common Return	Illuminates when channel is OFF and READY is active
PREVIEW Lamp	3	Open Collector to Logic Common Return	Illuminates when PREVIEW is ON
START Pulse	4	Open Collector to Logic Common Return	A 100 msec pulse when the channel status changes from OFF to ON
STOP Pulse	5	Open Collector to Logic Common Return	A 100 msec pulse when the channel status changes from ON to OFF
<b>POWER &amp; COMMON</b>			
Source Common	7	Logic Common	Connect to ground of source device or to Pin 8
Logic Common	8	Internal 5 Volt return	Can be connected to Pin 7 if source is not providing common
Logic + 5 Volt supply	9	Logic Supply, Individually Fused	Can be connected to Pin 10 if source is not providing voltage; active only when source has been assigned to channel.
Source Supply	10	Common for all 5 inputs	Connect to power supply of source device or to Pin 9
NOT CONNECTED	6		

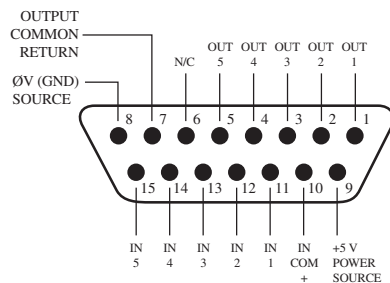

## GPIO Codec Logic

Name	Pin	Type	Notes
<b>INPUTS</b>			
ON Command	11	Active Low Input	Turns channel ON
OFF Command	12	Active Low Input	Turns channel OFF
TALK (to CR) Command	13	Active Low Input	Mutes channel outputs and routes source audio to PVW speakers
MUTE Command	14	Active Low Input	Mutes channel outputs
TALK (to SOURCE) Command	15	Active Low Input	Allows an external button to activate channel TALK TO SOURCE function.
<b>OUTPUTS</b>			
ON Lamp	1	Open Collector to Logic Common Return	Illuminates when channel is ON unless TALK or MUTE are active
OFF Lamp	2	Open Collector to Logic Common Return	Illuminates when channel is OFF.
TALK (to CR) Lamp	3	Open Collector to Logic Common Return	Illuminates when TALK is active
MUTE Lamp	4	Open Collector to Logic Common Return	Illuminates when MUTE is active
TALK (to SOURCE) Lamp	5	Open Collector to Logic Common Return	Illuminates when the channel TALK TO SOURCE function is active.
<b>POWER &amp; COMMON</b>			
Source Common	7	Logic Common	Connect to ground of source device or to Pin 8
Logic Common	8	Internal 5 Volt return	Can be connected to Pin 7 if source is not providing common
Logic + 5 Volt supply	9	Logic Supply, Individually Fused	Can be connected to Pin 10 if source is not providing voltage; active only when source has been assigned to channel.
Source Supply	10	Common for all 5 inputs	Connect to power supply of source device or to Pin 9
NOT CONNECTED	6		

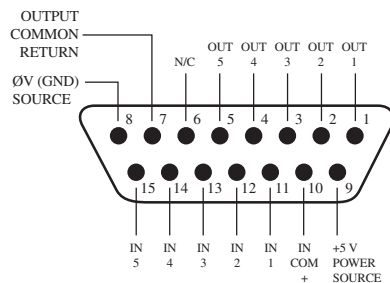

## GPIO Telephone Hybrid Logic

Name	Pin	Type	Notes
<b>INPUTS</b>			
ON Command	11	Active Low Input	Turns channel ON
OFF Command	12	Active Low Input	Turns channel OFF
PREVIEW Command	13	Active Low Input	Turns preview ON
RESET Command	14	Active Low Input	Turns channel off while not sending a STOP pulse
READY Command	15	Active Low Input	Illuminates OFF lamp to indicate source's readiness
<b>OUTPUTS</b>			
ON Lamp	1	Open Collector to Logic Common Return	Illuminates when channel is ON
OFF Lamp	2	Open Collector to Logic Common Return	Illuminates when channel is OFF
PREVIEW Lamp	3	Open Collector to Logic Common Return	Illuminates when PREVIEW is ON
START Pulse	4	Open Collector to Logic Common Return	A 100 ms PULSE is sent when channel is first turned ON or when PVW is first selected
STOP Pulse	5	Open Collector to Logic Common Return	A 100 ms PULSE sent when channel is turned OFF.
<b>POWER &amp; COMMAND</b>			
Source Common	7	Logic Common	Connect to ground of source device or to Pin 8
Logic Common	8	Internal 5 Volt return	Can be connected to Pin 7 if source is not providing common
Logic + 5 Volt supply	9	Logic Supply, Individually Fused	Can be connected to Pin 10 if source is not providing voltage; active only when source has been assigned to channel.
Source Supply	10	Common for all 5 inputs	Connect to power supply of source device or to Pin 9
NOT CONNECTED	6		

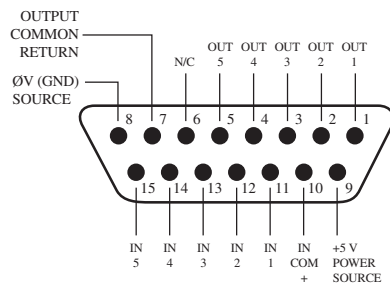

## GPIO Control Room Monitor Logic

Name	Pin	Type	Notes
<b>INPUTS</b>			
MUTE CR Command	11	Active Low Input	Mutes CR monitors and Pre-view speakers
DIM CR Command	12	Active Low Input	Allows external dimming of CR monitor speakers.
Enable EXT PREVIEW Com-mand	13	Active Low Input	Feeds External Audio Input to PREVIEW
TALK TO EXT Command	14	Active Low Input	Turns on Talk to External Audio.
Not used.	15	Active Low Input	
<b>OUTPUTS</b>			
CR ON AIR Lamp	1	Open Collector to Logic Com-mon Return	Illuminates whenever CR monitors are muted
DIM CR Lamp	2	Open Collector to Logic Com-mon Return	Illuminates whenever control room monitors are DIMMED
PREVIEW Lamp	3	Open Collector to Logic Com-mon Return	Illuminates when PREVIEW is active.
TALK TO EXT Lamp	4	Open Collector to Logic Com-mon Return	Illuminates when Talk to External is active.
TALK (to CR) Active Lamp	5	Open Collector to Logic Com-mon Return	Active whenever a source has activated its TALK (to CR) function
<b>POWER &amp; COMMON</b>			
Source Common	7	Logic Common	Connect to ground of source device or to Pin 8
Logic Common	8	Internal 5 Volt return	Can be connected to Pin 7 if source is not providing common
Logic + 5 Volt supply	9	Logic Supply, Individually Fused	Can be connected to Pin 10 if source is not providing voltage; active only when source has been assigned to channel.
Source Supply	10	Common for all 5 inputs	Connect to power supply of source device or to Pin 9
NOT CONNECTED	6		

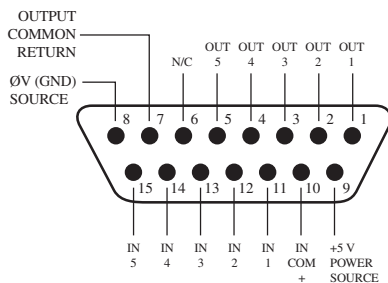

## GPIO Computer Playback Device Logic

Name	Pin	Type	Notes
<b>INPUTS</b>			
ON Command	11	Active Low Input	Turns channel ON
OFF Command	12	Active Low Input	Turns channel OFF & sends 100 msec STOP pulse
PREVIEW Command	13	Active Low Input	Turns preview ON
Not Used	14	Active Low Input	
READY Command	15	Active Low Input	Illuminates OFF lamp to indicate source's readiness
<b>OUTPUTS</b>			
NEXT Pulse	1	Open Collector to Logic Common Return	A 100 mS PULSE sent when ON button is depressed, except when initially turned ON.
OFF Lamp	2	Open Collector to Logic Common Return	Illuminates when channel is OFF and READY is active
PREVIEW Lamp	3	Open Collector to Logic Common Return	Illuminates when PREVIEW is ON
START Pulse	4	Open Collector to Logic Common Return	A 100 ms PULSE sent when channel is first turned ON.
STOP Pulse	5	Open Collector to Logic Common Return	A 100 ms PULSE sent when channel is turned OFF.
<b>POWER &amp; COMMON</b>			
Source Common	7	Logic Common	Connect to ground of source device or to Pin 8
Logic Common	8	Internal 5 Volt return	Can be connected to Pin 7 if source is not providing common
Logic + 5 Volt supply	9	Logic Supply, Individually Fused	Can be connected to Pin 10 if source is not providing voltage; active only when source has been assigned to channel.
Source Supply	10	Common for all 5 inputs	Connect to power supply of source device or to Pin 9
NOT CONNECTED	6		

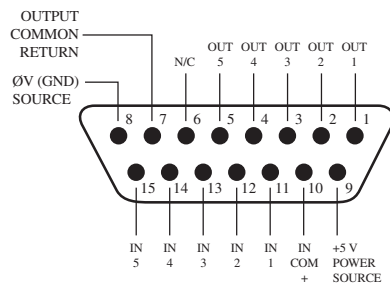



# Appendix B:

## xNode Specifications

---

### Microphone Preamplifiers

- Source Impedance: 150 ohms
- Input Impedance: 4 k ohms minimum, balanced
- Nominal Level Range: Adjustable, -75 dBu to -20 dBu
- Input Headroom: >20 dB above nominal input
- Phantom power: +48VDC, switchable

### Analog Line Inputs

- Input Impedance: >40 k ohms, balanced
- Nominal Input Range: Selectable, +4 dBu or -10dBv
- Input Headroom: 20 dB above nominal input

### Analog Line Outputs

- Output Source Impedance: <50 ohms balanced
- Output Load Impedance: 600 ohms, minimum
- Nominal Output Level: +4 dBu
- Maximum Output Level: +24 dBu

### Digital Audio Inputs and Outputs

- Reference Level: +4 dBu (-20 dB FSD)
- Impedance: 110 Ohm, balanced
- Signal Format: AES3 (AES/EBU)
- AES3 Input Compliance: 24-bit with sample rate conversion
- AES3 Output Compliance: 24-bit
- Digital Reference: Internal (network timebase) or external reference 48 kHz, +/- 2 ppm
- Internal Sampling Rate: 48 kHz
- Input Sample Rate: 32 kHz to 192 kHz
- Output Sample Rate: 44.1 kHz or 48 kHz
- A/D Conversions: 24-bit, Delta-Sigma, 256x oversampling
- D/A Conversions: 24-bit, Delta-Sigma, 256x oversampling

### Frequency Response

- Any input to any output: +/- 0.5 dB, 20 Hz to 20 kHz

### Latency

- Analog Input to Analog Output, 2.75ms including network, converters, and mixing process
- Digital Input to Digital Output, 1.75ms including network mixing engine (ASRC off)

## Dynamic Range

- Analog Inputs to Analog Outputs 108dB referenced to 0dBFs, 111dB A-weighted
- Analog Inputs to Digital Outputs 110dB referenced to 0dBFs, 113dB A-weighted
- Digital Inputs to Analog Outputs 112dB referenced to 0dBFs, 115dB A-weighted
- Digital Inputs to Digital Outputs 126dB

## Equivalent Input Noise

- Microphone Preamp: -128 dBu, 150 ohm source, reference -50 dBu input level

## Total Harmonic Distortion + Noise

- Mic Pre Input to Analog Output: < 0.005%, 1 kHz, -36dBu input, +18dBu output
- Analog Input to Analog Output: < 0.005%, 1 kHz, +18dBu input, +18dBu output
- Analog Input to Digital Output: < 0.004%, 1 kHz, +18dBu input, -6dBFs output
- Digital Input to Analog Output: < 0.004%, 1 kHz, -6dBFs input, +18dBu output
- Digital Input to Digital Output: < 0.0003%, 1 kHz, -20dBFs

## Crosstalk Isolation, Stereo Separation and CMRR

- Analog Line channel to channel isolation: 90dB minimum, 20Hz to 20kHz
- Analog Line stereo separation: 85dB minimum, 20Hz to 20kHz
- Analog Line Input CMRR: 80dB minimum, 20Hz to 20kHz
- Microphone Input CMRR: >60 dB, 20 Hz to 20 kHz

## Power Supply AC Input

- Auto-ranging supply, 95VAC to 240VAC, 50 Hz to 60 Hz,
- IEC receptacle, internal fuse
- Power consumption: 14 Watts

## Operating Temperatures

- 0 degree C to +40 degree C, <90% humidity, no condensation

## Dimensions and Weight

- 8.5" (22 cm) wide; two may be mounted side-by-side in a standard 1RU rack space (with accessory mounting kit)
- 1.72" (4.4 cm) height, 11.75" (30 cm) depth
- Shipping Weight: 7 lbs. (3.2 kg.)
- Shipping Dimensions: 17" (43.2 cm) length,
- 13" (33 cm) width, 7" (17.8 cm) height

# Appendix C:

## AES67

---

AES67 standard defines an interoperability mode for transport of highperformance audio over networks based on the Internet Protocol. For the purposes of the standard, highperformance audio refers to audio with full bandwidth and low noise . These requirements imply linear PCM coding with a sampling frequency of 44,1 kHz and higher and resolution of 16 bits and higher. High performance also implies a lowlatency capability compatible with live sound applications. The standard considers latency performance of 10 milliseconds or less.

xNodes implementation is compliant with the standard supporting interoperability with third party devices. In particular, the following features are implemented:

- Multicast and unicast Real Time Protocol (RTP) audio streaming
- Session Initiation Protocol (SIP) based connection management for unicast streams
- Transmission of 1ms audio frames in linear PCM 24bit format
- Ability to receive audio streams containing 1 through 8 channels
- Ability to receive 16bit as well as 24bit format
- Support of IEEE15882001 Precision Time Protocol standard
- Timestamping outgoing stream with IEEE1588 derived RTP timestamps

### Network synchronization setup

AES67 standard requires device to use IEEE1588 network time protocol standard. The *Synchronization and QoS* page of the xNode provides the controls to establish the xNode as a system PTP master or slave to a grand master.

Clock mode options allow selecting the operation suitable to the system in which the xNode is being deployed.

- PTP/IEEE 1588 ARB clock class 248 mode allows the node to be a master when no better clock is available on the network. Since xNodes are not locked to GPS or any other high precision source, only Arbitrary (ARB) Clock class is provided.
- PTP/IEEE 1588 slave only is recommended for networks with high precision grand masters present.
- Additional options are same as above with Livewire master conditions to allow the xNode to act as a gateway for synchronization to Livewire legacy products.

PTP domain number should be selected to 0 unless there is a need for multiple clock domains on a network segment. PTP delay mechanism specifies how the node determines network round trip latency. This setting MUST match the master clock setting. In practice, EndtoEnd (E2E) is always used by ordinary clocks and boundary clocks. Peerto-Peer (P2P) mechanism was defined to limit amount of traffic reaching the master clock, but is rarely used.

PTP clock priority1/priority2 numbers provide a control over master clock selection. Lower priority number makes the clock a preferred choice over devices with a higher number. The range is 0255, and 128 is the default and middle value.

PTP clock sync interval determines how often clock packets are sent. The faster those packets are sent, the faster and more accurate synchronization can be achieved. Some IEEE1588 devices do not support lower clock sync interval than 0.5s, so this setting may need to be adjusted depending on what other networking equipment is used. AES67 recommends an interval of 1/8 (8 packets per second). This setting affects behavior of the master clock and does nothing when the node is a slave.

## AES67 Multicast connection setup

xNode transmits a multicast streams as soon as Source is configured with a Livewire channel number or multicast IP address and Stream Mode is set to a value other than “disabled”. AES67 requires devices to support reception of at least 1ms frames this corresponds to “Low Latency Stereo” Stream Mode setting. Other settings will work if the receiver supports different frame sizes in addition to the required 1ms.

### Sources

#	Source Name:	Channel/Address:	Stream Mode:	Input Gain [dB]:
1	<input type="text" value="SRC 1"/>	<input type="text" value="238.194.0.1"/>	Low Latency Stereo ▼	<input type="text" value="0.0"/>

[AES67: Download stream description \(SDP\), RTSP: rtsp://192.168.100.201/by-id/1](#)

Figure App-1: Example of a 2-channel, 24-bit, 1ms frame, multicast stream to group 238.194.0.1

The Session Description (SDP) can be downloaded from xNode by clicking on the ‘AES67: Download stream description (SDP)’ link.

In order to receive AES67 multicasts stream the multicast address of the stream would be enter into the Channel/Address field of the Destination page.

### Destinations

#	Name:	Channel/Address:	Type:	Gain [dB]:
AES 1	<input type="text" value="DST 1"/>	<input type="text" value="238.194.0.1"/>	From source ▼	<input type="text" value="0.0"/>

Figure App-2: Example of receiving a multicast stream

This method of configuration for multicast reception requires the source to transmit in PCM 24bit stereo or 8channel format. To receive other forms, follow the multicast group with information about the stream as follows:

```
{multicast group};{bit rate}/{sample rate}/{channels}
238.194.0.2;L16/44100/2
```

Surround 8channel reception is set up by selecting Destination Type: Surround.

Channel/Address field accepts optional UDP port number following IP address, separated with a “:”. This is useful option when the port number is different than RTP default 5004.

## AES67 Unicast Setup

Each Source of an xNode can be configured as a multicast sender, or unicast port supporting a single listener/receiver. Unicast configuration is achieved by clearing the Channel/Address field in the Source page setup.

### Sources

---

#	Source Name:	Channel/Address:	Stream Mode:	Input Gain [dB]:
1	<input type="text" value="SRC 1"/>	<input type="text"/>	Low Latency Stereo ▼	<input type="text" value="0.0"/>

AES67: sip:1@192.168.100.72, RTSP: rtsp://192.168.100.72/by-id/1

Figure App-3: Example of source configuration for unicast mode.

---

The media stream is accessed using a SIP URI (Session Announcement Protocol Uniform Resource Identifier). It contains “sip:” prefix, followed by Source/Destination port number, ‘@’ sign and IP address of the node.

The xNode provides the address on the Sources WEB page so it can be copied conveniently. This can be found next to the AES67 text. In the figure 3 example, the text to be copied is *sip:1@192.168.100.72*.

In Unicast mode, Source accepts SIP connections. There are a few possible scenarios:

- Receiveonly connection (SIP Invitation with recvonly attribute specified in the SDP block). After answering, xNode will start sending stream to the originator of the connection. Media format follows current Source configuration.
- Sendonly connection (SIP Invitation with sendonly attribute specified in the SDP block). After answering, xNode will start receiving the stream which can be 16bit or 24bit with channel count from 1 to 8. This type of a connection required the corresponding Destination to be not configured (empty Channel/Address) field.
- Bidirectional (default SIP invitation). xNode will receive and send. The media format must be 24bit. This type of a connection required the corresponding Destination to be not configured (empty Channel/Address) field.

In order to setup AES67 Unicast stream receive, enter the SIP URI stream address in Channel/Address field of a destination.

### Destinations

---

#	Name:	Channel/Address:	Type:	Gain [dB]:
AES 1	<input type="text" value="DST 1"/>	<input type="text" value="sip:1@192.168.100.72"/>	From source ▼	<input type="text" value="0.0"/>

Figure App-4: Example of unicast receive setup

---

The xNode makes a SIP call to the specified source. The call is receiveonly (issued with recvonly SIP/SDP media attribute specified).

The xNode will provide status of the unicast connection on the front panel. Small triangle icons below the meters show the current status:

- If no triangle is shown, the Source and Destination port is not configured for Unicast.
- If the triangle is blinking, the port is configured for Unicast, but there is no active connection.
- When the triangle is displayed solid on, there is a Unicast Link established to that port.

Channel/Address field accepts optional UDP port number in the URI, separated with a “:” from the address part. This is needed when the port number used by sender is different than SIP default 5060.

# Appendix D:

## Telos Alliance Limited Warranty

---



For the latest Telos Alliance warranty, visit: [telosalliance.com/warranty](https://telosalliance.com/warranty).



## THE TELOS ALLIANCE®